

# ESM-APLM

Intel® Celeron®/ Pentium® SoC Processor COM Express  
Mini Size Type 10 Module

## User's Manual

1<sup>st</sup> Ed –14 November 2018

### Copyright Notice

Copyright © 2018 Avalue Technology Inc., ALL RIGHTS RESERVED.

Part No. E2047288700R

## **FCC Statement**



THIS DEVICE COMPLIES WITH PART 15 FCC RULES. OPERATION IS SUBJECT TO THE FOLLOWING TWO CONDITIONS:

(1) THIS DEVICE MAY NOT CAUSE HARMFUL INTERFERENCE.

(2) THIS DEVICE MUST ACCEPT ANY INTERFERENCE RECEIVED INCLUDING INTERFERENCE THAT MAY CAUSE UNDESIRE OPERATION.

THIS EQUIPMENT HAS BEEN TESTED AND FOUND TO COMPLY WITH THE LIMITS FOR A CLASS "A" DIGITAL DEVICE, PURSUANT TO PART 15 OF THE FCC RULES.

THESE LIMITS ARE DESIGNED TO PROVIDE REASONABLE PROTECTION AGAINST HARMFUL INTERFERENCE WHEN THE EQUIPMENT IS OPERATED IN A COMMERCIAL ENVIRONMENT. THIS EQUIPMENT GENERATES, USES, AND CAN RADIATE RADIO FREQUENCY ENERGY AND, IF NOT INSTALLED AND USED IN ACCORDANCE WITH THE INSTRUCTION MANUAL, MAY CAUSE HARMFUL INTERFERENCE TO RADIO COMMUNICATIONS.

OPERATION OF THIS EQUIPMENT IN A RESIDENTIAL AREA IS LIKELY TO CAUSE HARMFUL INTERFERENCE IN WHICH CASE THE USER WILL BE REQUIRED TO CORRECT THE INTERFERENCE AT HIS OWN EXPENSE.

## **Notice**

This guide is designed for experienced users to setup the system within the shortest time. For detailed information, please always refer to the electronic user's manual.

## **Copyright Notice**

Copyright © 2018 Avalue Technology Inc., ALL RIGHTS RESERVED.

No part of this document may be reproduced, copied, translated, or transmitted in any form or by any means, electronic or mechanical, for any purpose, without the prior written permission of the original manufacturer.

## **Trademark Acknowledgement**

Brand and product names are trademarks or registered trademarks of their respective owners.

## **Disclaimer**

Avalue Technology Inc. reserves the right to make changes, without notice, to any product, including circuits and/or software described or contained in this manual in order to improve design and/or performance. Avalue Technology assumes no responsibility or liability for the use of the described product(s), conveys no license or title under any patent, copyright, or masks work rights to these products, and makes no representations or warranties that

these products are free from patent, copyright, or mask work right infringement, unless otherwise specified. Applications that are described in this manual are for illustration purposes only. Avalue Technology Inc. makes no representation or warranty that such application will be suitable for the specified use without further testing or modification.

## **Life Support Policy**

Avalue Technology's PRODUCTS ARE NOT FOR USE AS CRITICAL COMPONENTS IN LIFE SUPPORT DEVICES OR SYSTEMS WITHOUT THE PRIOR WRITTEN APPROVAL OF Avalue Technology Inc.

As used herein:

1. Life support devices or systems are devices or systems which, (a) are intended for surgical implant into body, or (b) support or sustain life and whose failure to perform, when properly used in accordance with instructions for use provided in the labeling, can be reasonably expected to result in significant injury to the user.
2. A critical component is any component of a life support device or system whose failure to perform can be reasonably expected to cause the failure of the life support device or system, or to affect its safety or effectiveness.

## **A Message to the Customer**

### ***Avalue Customer Services***

Each and every Avalue's product is built to the most exacting specifications to ensure reliable performance in the harsh and demanding conditions typical of industrial environments. Whether your new Avalue device is destined for the laboratory or the factory floor, you can be assured that your product will provide the reliability and ease of operation for which the name Avalue has come to be known.

Your satisfaction is our primary concern. Here is a guide to Avalue's customer services. To ensure you get the full benefit of our services, please follow the instructions below carefully.

### ***Technical Support***

We want you to get the maximum performance from your products. So if you run into technical difficulties, we are here to help. For the most frequently asked questions, you can easily find answers in your product documentation. These answers are normally a lot more detailed than the ones we can give over the phone. So please consult the user's manual first.

To receive the latest version of the user's manual; please visit our Web site at:

<http://www.avalue.com.tw/>

# CONTENT

<b>1. Getting Started</b>	<b>7</b>
1.1 Safety Precautions	7
1.2 Packing List	7
1.3 Document Amendment History	8
1.4 Manual Objectives	9
1.5 System Specifications	10
1.6 Architecture Overview—Block Diagram	13
<b>2. Hardware Configuration</b>	<b>14</b>
2.1 Product Overview	15
2.2 Connector List	16
2.3 Setting Jumpers & Connectors	17
2.3.1 AT/ATX mode selector (SW1)	17
2.3.1.1 Signal Description –AT/ATX mode selection	17
2.3.2 COM Express Connector 1 (CN1A)	18
2.3.2.1 Signal Description – COM Express Connector 1 (CN1A)	22
2.3.2.1.1 Audio Signals	22
2.3.2.1.2 Gigabit Ethernet Signals	22
2.3.2.1.3 PCI Express Signals	22
2.3.2.1.4 Flat Panel LVDS Signals	22
2.3.2.1.5 LPC Signals	23
2.3.2.1.6 GPIO Signals	23
2.3.2.1.7 Power & System Management Signals	23
2.3.2.1.8 SATA Signals	24
2.3.2.1.9 USB Signals	24
2.3.2.1.10 I2C Signals	24
2.3.2.1.11 USB3.0 Signals	24
2.3.2.1.12 DDI Signals	24
2.4 Installing Heatsink / Heat spreader	26
<b>3. BIOS Setup</b>	<b>29</b>
3.1 Introduction	30
3.2 Starting Setup	30
3.3 Using Setup	31
3.4 Getting Help	32
3.5 In Case of Problems	32

3.6 BIOS setup..... 33

3.6.1 Main Menu..... 33

    3.6.1.1 System Language..... 34

    3.6.1.2 System Date ..... 34

    3.6.1.3 System Time..... 34

3.6.2 Advanced Menu ..... 34

    3.6.2.1 Trusted Computing ..... 35

    3.6.2.2 APCI Settings ..... 35

    3.6.2.3 SMART Settings ..... 36

    3.6.2.4 IT8528 Super IO Configuration..... 37

        3.6.2.4.1 Serial Port 1 Configuration ..... 37

        3.6.2.4.2 Serial Port 2 Configuration ..... 38

    3.6.2.5 S5 RTC Wake Settings..... 39

    3.6.2.6 Serial Port Console Redirection ..... 41

        3.6.2.6.1 COM0 ..... 41

        3.6.2.6.2 Legacy Console Redirection Settings ..... 43

        3.6.2.6.3 Console Redirection Settings ..... 44

    3.6.2.7 CPU Configuration..... 45

        3.6.2.7.1 Socket 0 CPU Information ..... 45

        3.6.2.7.2 CPU Power Management Configuration ..... 46

    3.6.2.8 Network Stack Configuration ..... 47

    3.6.2.9 CSM Configuration ..... 48

    3.6.2.10 USB Configuration ..... 50

    3.6.2.11 Security Configuration ..... 51

3.6.3 Chipset..... 52

    3.6.3.1 North Bridge..... 52

    3.6.3.2 South Bridge ..... 53

    3.6.3.3 Uncore Configuration ..... 53

    3.6.3.4 South Cluster Configuration..... 55

        3.6.3.4.1 HD-Audio Configuration ..... 55

        3.6.3.4.2 PCI Express Configuration ..... 56

            3.6.3.4.2.1 PCIE1 #1 ..... 56

            3.6.3.4.2.2 PCIE1 #2 ..... 57

            3.6.3.4.2.3 PCIE1 #3 ..... 58

            3.6.3.4.2.4 i211 on Module/PCIE1 #4 ..... 59

            3.6.3.4.2.5 PCIe B-0..... 60

        3.6.3.4.3 SATA Drivers ..... 61

        3.6.3.4.4 SCC Configuration..... 62

        3.6.3.4.4 USB Configuration ..... 63

3.6.4 Security..... 64

## **ESM-APLM User's Manual**

3.6.4.1	Secure Boot .....	64
3.6.5	Boot .....	65
3.6.6	Save and exit.....	66
3.6.6.1	Save Changes and Reset.....	66
3.6.6.2	Discard Changes and Reset.....	66
3.6.6.3	Restore Defaults .....	66
3.6.6.4	Launch EFI Shell from filesystem device .....	67
<b>4.</b>	<b>Drivers Installation.....</b>	<b>68</b>
4.1	Install Chipset Driver .....	69
4.2	Install TXE Driver .....	70
4.3	Install VGA Driver.....	71
4.4	Install Audio Driver .....	73
4.5	Install Ethernet Driver.....	74
<b>5.</b>	<b>Mechanical Drawing .....</b>	<b>76</b>

# 1. Getting Started

## 1.1 Safety Precautions

### Warning!



Always completely disconnect the power cord from your chassis whenever you work with the hardware. Do not make connections while the power is on. Sensitive electronic components can be damaged by sudden power surges. Only experienced electronics personnel should open the PC chassis.

### Caution!



Always ground yourself to remove any static charge before touching the CPU card. Modern electronic devices are very sensitive to static electric charges. As a safety precaution, use a grounding wrist strap at all times. Place all electronic components in a static-dissipative surface or static-shielded bag when they are not in the chassis.

## 1.2 Packing List

Before you begin installing your single board, please make sure that the following materials have been shipped:

- 1 x ESM-APLM COMe Module
- 1 x Desiccant (5g)
- Screws kit:

For installing COMe Module + Heatsink / Heat spreader & Carrier Board  
- M2.5-12L Ni \* 4pcs



---

If any of the above items is damaged or missing, contact your retailer.

---

### 1.3 Document Amendment History

Revision	Date	By	Comment
1 <sup>st</sup>	November 2018	Avalue	Initial Release



## 1.4 Manual Objectives

This manual describes in details Avalue Technology ESM-APLM Single Board.

We have tried to include as much information as possible but we have not duplicated information that is provided in the standard IBM Technical References, unless it proved to be necessary to aid in the understanding of this board.

We strongly recommend that you study this manual carefully before attempting to set up ESM-APLM series or change the standard configurations. Whilst all the necessary information is available in this manual we would recommend that unless you are confident, you contact your supplier for guidance.

Please be aware that it is possible to create configurations within the NVRAM that make booting impossible. If this should happen, clear the NVRAM settings, (see the description of the Jumper Settings for details).

If you have any suggestions or find any errors regarding this manual and want to inform us of these, please contact our Customer Service department with the relevant details.

## 1.5 System Specifications

<b>System</b>	
<b>CPU</b>	Intel® Pentium® N4200 2.50 GHz (Burst)   1.1 GHz Clock Quad Core L2 cache 2MB 6W TDP Intel® Celeron® N3350 2.40 GHz (Burst)   1.1 GHz Clock Dual Core L2 cache 1MB 6W TDP
<b>BIOS</b>	AMI UEFI BIOS, 128Mbit SPI Flash ROM
<b>System Chipset</b>	Integrated in SoC
<b>I/O Chip</b>	IT8528
<b>System Memory</b>	Onboard DDR3L memory support for up to 8 GByte at 1866MT/s
<b>TPM</b>	65536 level, 0 ~ 65535 sec
<b>Watchdog Timer</b>	H/W Reset, 1sec. ~ 65535sec. and 1sec./step
<b>H/W Status Monitor</b>	Monitoring System Temperature, Voltage and FAN Status
<b>Expansion</b>	1 PCIe 4 (Supports x1, x2, x4, optional 1 PCIe4 while removing Ethernet) compliant to PCIe Gen2 5.0 GT/s LPC Bus, SM Bus (system)
<b>I/O</b>	
<b>USB</b>	2 x USB 3. 1 (Gen1) and 8 x USB 2.0
<b>SATA</b>	2 x SATA 3.0 (6 Gb/s)
<b>eMMC</b>	eMMC 5.1 up to 128G (optional)
<b>PCIe</b>	1 PCIe 4 (Supports x1, x2, x4, optional 1 PCIe4 while removing Ethernet) compliant to PCIe Gen2 5.0 GT/s
<b>Display</b>	
<b>GPU Feature Support</b>	Intel® Generation 9 LP Graphics Core Architecture, supporting 2 independent and simultaneous display combinations of DisplayPort, HDMI, LVDS or eDP outputs Hardware encode/transcode (including HEVC) DirectX 12, DirectX 11.3, DirectX 10, DirectX 9.3 support OpenGL 4.3 and ES 3.0 support OpenCL 2.0 support
<b>Digital Display Interface</b>	DDI0 supports DisplayPort/HDMI/DVI-D DisplayPort 1.2 up to 4096 x 2160@60Hz HDMI 1.4b: up to 3840 x 2160 @ 30 Hz
<b>LVDS</b>	Single channel 18/24-bit LVDS from eDP-to-LVDS IC CH7511B LVDS: up to 1366 x 768 @ 60 Hz
<b>eDP</b>	4 lane support (build option, in place of LVDS) eDP 1.3: up to 3840 x 2160 @ 60 Hz (Optional)
<b>Audio</b>	

<b>Chipset</b>	Intel® HD Audio integrated in SoC
<b>Audio Codec</b>	On carrier board
<b>Ethernet</b>	
<b>Intel® MAC/PHY</b>	1 x LAN Intel® Ethernet I211AT
<b>Interface</b>	10/100/1000 GbE connection
<b>Mechanical &amp; Environmental</b>	
<b>Power Requirement</b>	Standard Input ATX: 4.75V~20V, 5Vsb ±5%; AT: 4.75V~20V
<b>Operating Temp.</b>	Standard: 0°C to 60°C (32°F ~ 140°F)
<b>Storage Temp.</b>	-40°C ~ 75°C (-40°F ~ 167°F)
<b>Operating Humidity</b>	5-90% RH operating, non-condensing 5-95% RH storage (and operating with conformal coating)
<b>Random Vibration Test - Operation - Non-operation</b>	<b><u>Operation</u></b> 1 PSD: 0.00454G <sup>2</sup> /Hz, 1.5 Grms 2 Operation mode 3 Test Frequency : 5-500Hz 4 Test Axis : X,Y and Z axis 5 30 min. per each axis 6 IEC 60068-2-64 Test:Fh <b><u>Non-Operation</u></b> 1 PSD: 0.01818G <sup>2</sup> /Hz, 3.0 Grms 2 Non-Operation mode 3 Test Frequency : 5-500Hz 4 Test Axis : X,Y and Z axis 5 30 min. per each axis 6 IEC 60068-2-64 Test:Fh
<b>Package Vibration Test</b>	1. PSD: 0.026G <sup>2</sup> /Hz , 2.16 Grms 2. Non-operation mode 3. Test Frequency : 5-500Hz 4. Test Axis : X,Y and Z axis 5. 30 min. per each axis 6. IEC 60068-2-64 Test:Fh
<b>Package Drop Test</b>	1 One corner , three edges, six faces 2 ISTA 2A, IEC-60068-2-32 Test:Ed
<b>Misuse Test</b>	Follow DQV test method
<b>Short test</b>	Follow DQV test method
<b>Size (L x W)</b>	84 x 55 mm (3.31" x 2.17")

## ESM-APLM User's Manual

<b>OS</b>	Microsoft® Windows 10 Linux (Kernel 4.6 above)
<b>Thermal Solution</b>	Implementing the new thermal design conception which adds the screw hole next to the SoC to fix the thermal module. 1.Heatsink w/o Fan 2.Heat spreader



**Note:** Specifications are subject to change without notice.

# 1.6 Architecture Overview—Block Diagram

The following block diagram shows the architecture and main components of ESM-APLM.

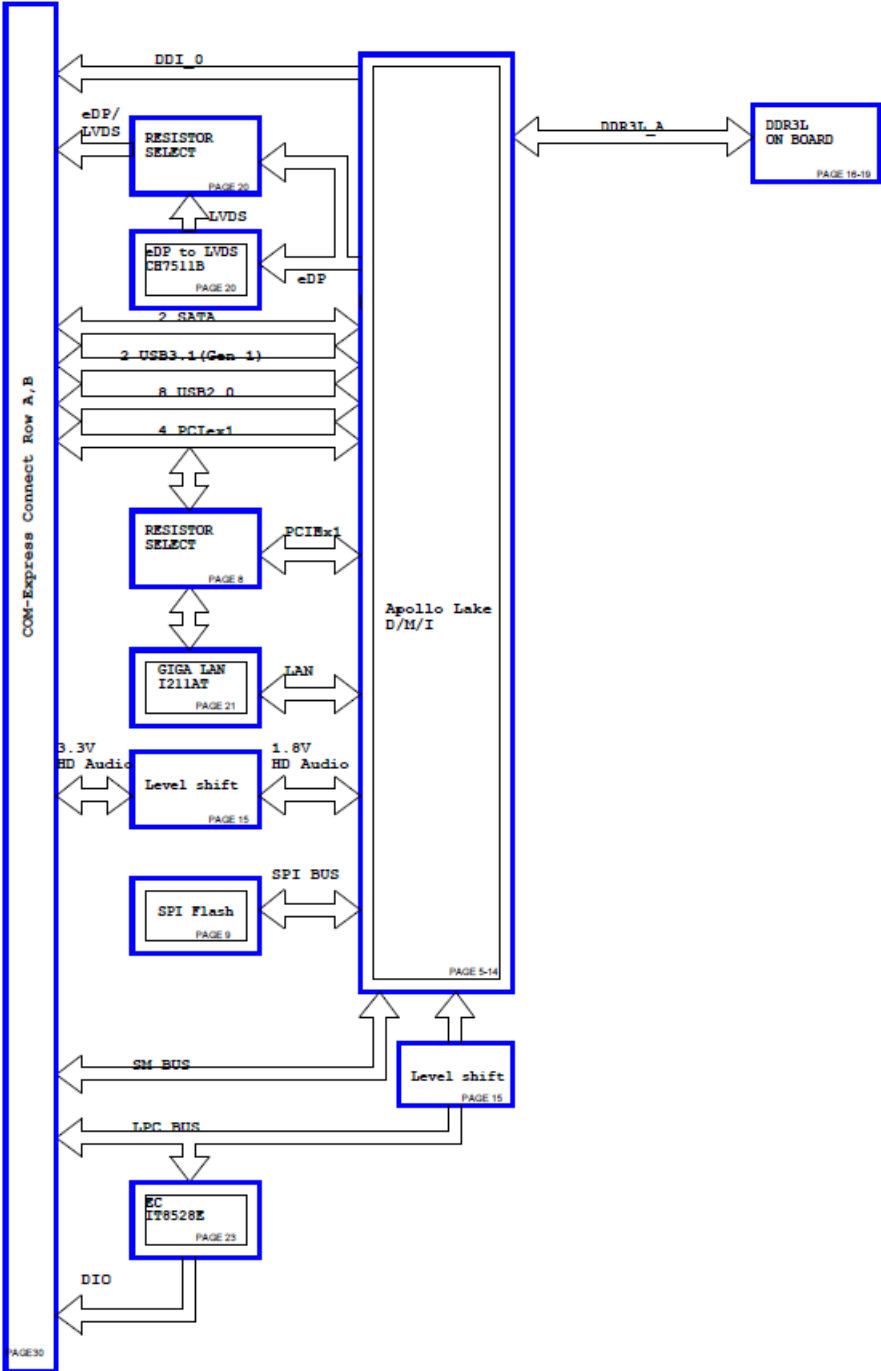

# 2. Hardware Configuration

---

2.1 Product Overview

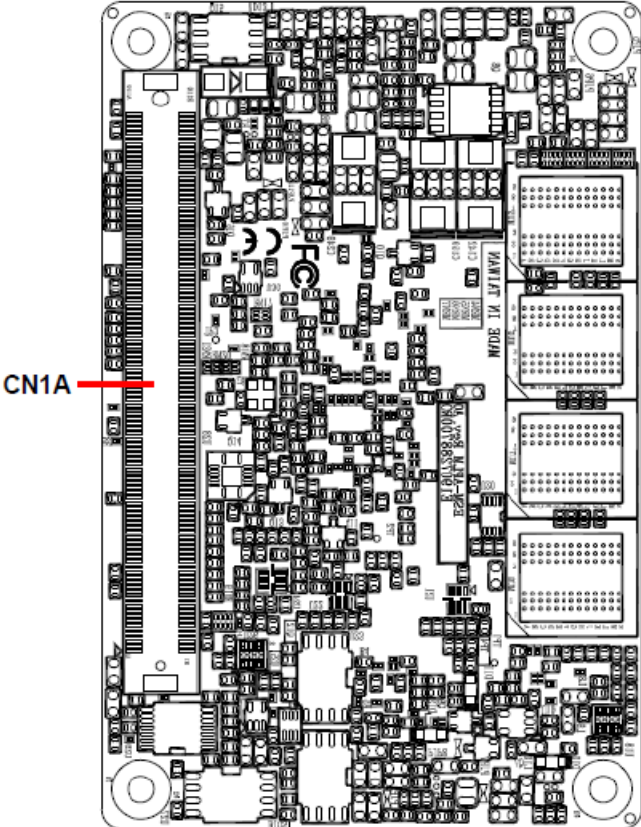
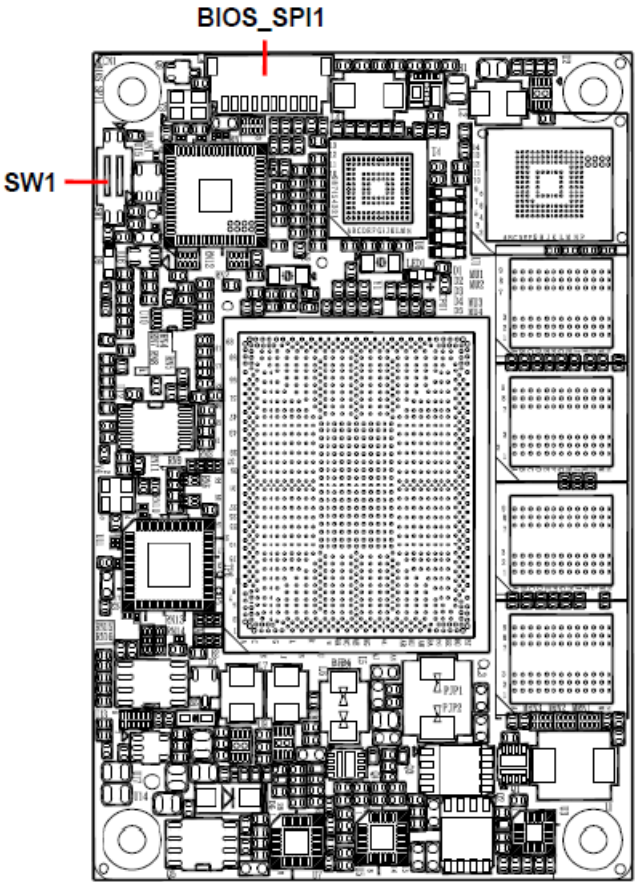

## 2.2 Connector List

You can configure your board to match the needs of your application by setting jumpers. A jumper is the simplest kind of electric switch.

It consists of two metal pins and a small metal clip (often protected by a plastic cover) that slides over the pins to connect them. To “close” a jumper you connect the pins with the clip. To “open” a jumper you remove the clip. Sometimes a jumper will have three pins, labeled 1, 2, and 3. In this case, you would connect either two pins.

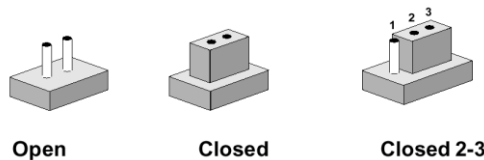

The jumper settings are schematically depicted in this manual as follows:



A pair of needle-nose pliers may be helpful when working with jumpers.

Connectors on the board are linked to external devices such as hard disk drives, a keyboard, or floppy drives. In addition, the board has a number of jumpers that allow you to configure your system to suit your application.

If you have any doubts about the best hardware configuration for your application, contact your local distributor or sales representative before you make any changes.

The following tables list the function of each of the board's jumpers and connectors.

### Connectors

Label	Function	Note
BIOS_SPI1	(Reserved for BIOS programming)	5 x 2 header, pitch 2.00mm
CN1A	COM Express connector 1	
SW1	AT/ATX mode selector	



**2.3 Setting Jumpers & Connectors**

**2.3.1 AT/ATX mode selector (SW1)**

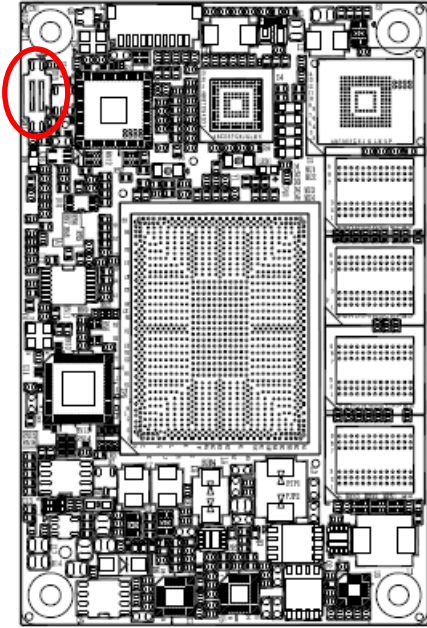

AT/ATX mode



AT mode\*

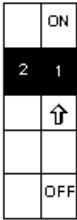

ATX mode

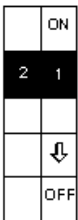

\*Default

**2.3.1.1 Signal Description –AT/ATX mode selection**

AT/ATX mode	Description
<p>AT mode</p>	<p>Auto-power on, no need to press Power button to enable power on/off</p>
<p>ATX mode</p>	<p>Press the power button to enable power on/off</p>

2.3.2 COM Express Connector 1 (CN1A)

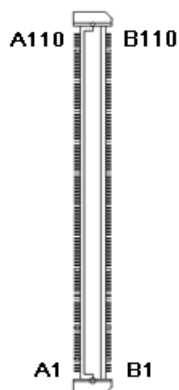
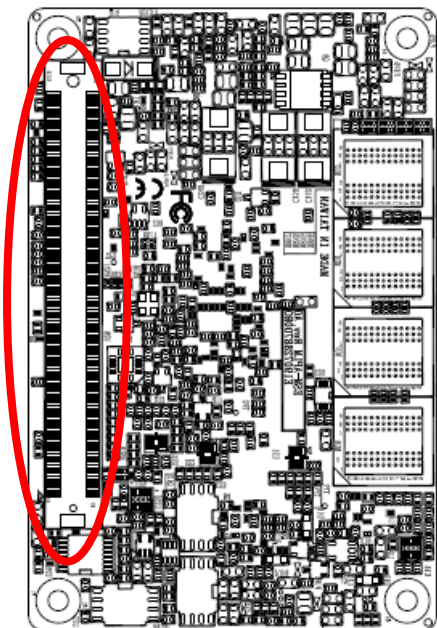

Signal	PIN	PIN	Signal
GND	A110	B110	GND
VCC	A109	B109	VCC
VCC	A108	B108	VCC
VCC	A107	B107	VCC
VCC	A106	B106	VCC
VCC	A105	B105	VCC
VCC	A104	B104	VCC
LID#	A103	B103	SLEEP#
SER1_RX	A102	B102	NC
SER1_TX	A101	B101	NC
GND	A100	B100	GND
SER0_RX	A99	B99	DDIO_CTRLDATA_AUX-
SER0_TX	A98	B98	DDIO_CTRLCLK_AUX+
TYPE10#	A97	B97	NC
NC	A96	B96	USB_HOST_PRSENT
NC	A95	B95	DDIO_DDC_AUX_SEL
NC	A94	B94	NC
GPO0	A93	B93	NC
NC	A92	B92	NC
NC	A91	B91	NC
GND	A90	B90	GND
PCIE_CLK_REF-	A89	B89	DDIO_HPD
PCIE_CLK_REF+	A88	B88	NC
CB_EDP_HDP	A87	B87	+ATX5VSB
NC	A86	B86	+ATX5VSB
GPI3	A85	B85	+ATX5VSB
LVDS_I2C_DAT/EDP_AUX-	A84	B84	+ATX5VSB
LVDS_I2C_CK/EDP_AUX+	A83	B83	LVDS_BKLT_CTRL/ EDP_BKLT_CTRL
LVDS_A_CK-/EDP_TX3-	A82	B82	DDIO_PAIR3-
LVDS_A_CK+/EDP_TX3+	A81	B81	DDIO_PAIR3+

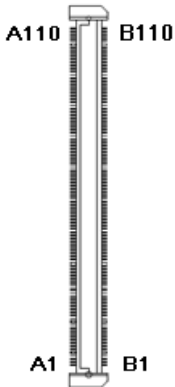
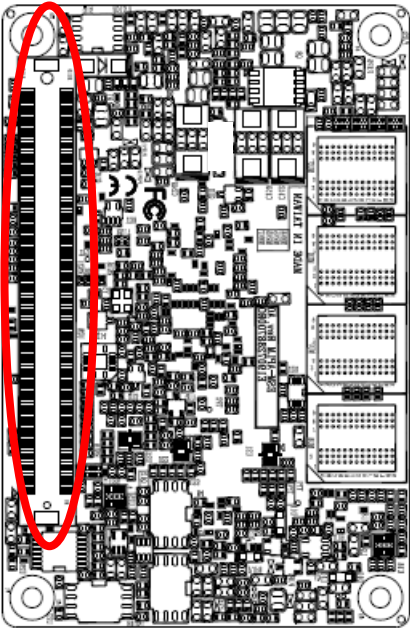

Signal	PIN	PIN	Signal
GND	A80	B80	GND
LVDS_A3-	A79	B79	LVDS_BKLT_EN/ EDP_BKLT_EN
LVDS_A3+	A78	B78	NC
LVDS_VDD_EN/EDP_VDD_EN	A77	B77	NC
LVDS_A2-/EDP_TX0-	A76	B76	DDIO_PAIR2-
LVDS_A2+/EDP_TX0+	A75	B75	DDIO_PAIR2+
LVDS_A1-/EDP_TX1-	A74	B74	DDIO_PAIR1-
LVDS_A1+/EDP_TX1+	A73	B73	DDIO_PAIR1+
LVDS_A0-/EDP_TX2-	A72	B72	DDIO_PAIR0-
LVDS_A0+/EDP_TX2+	A71	B71	DDIO_PAIR0+
GND	A70	B70	GND
PCIE_TX0-	A69	B69	PCIE_RX0-
PCIE_TX0+	A68	B68	PCIE_RX0+
GPI2	A67	B67	WAKE1#
GND	A66	B66	WAKE0#
PCIE_TX1-	A65	B65	PCIE_RX1-
PCIE_TX1+	A64	B64	PCIE_RX1+
GPI1	A63	B63	GPO3
PCIE_TX2-	A62	B62	PCIE_RX2-
PCIE_TX2+	A61	B61	PCIE_RX2+
GND	A60	B60	GND
PCIE_TX3-	A59	B59	PCIE_RX3-
PCIE_TX3+	A58	B58	PCIE_RX3+
GND	A57	B57	GPO2
NC	A56	B56	NC
NC	A55	B55	NC
GPI0	A54	B54	GPO1
NC	A53	B53	NC
NC	A52	B52	NC
GND	A51	B51	GND

# ESM-APLM User's Manual

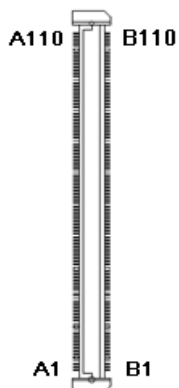
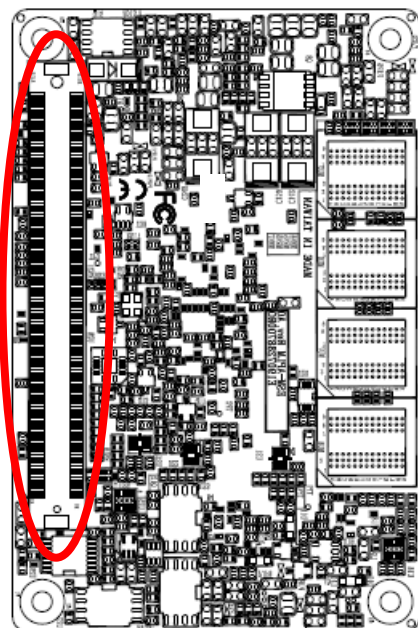

Signal	PIN	PIN	Signal
LPC_SERIRQ	A50	B50	CB_RESET#
GBE0_SDP	A49	B49	SYS_RESET#
NC	A48	B48	USB0_HOST_PRSNT
+3.3V	A47	B47	ESPI_EN#
USB0+	A46	B46	USB1+
USB0-	A45	B45	USB1-
USB_2_3_OC#	A44	B44	USB_0_1_OC#
USB2+	A43	B43	USB3+
USB2-	A42	B42	USB3-
GND	A41	B41	GND
USB4+	A40	B40	USB5+
USB4-	A39	B39	USB5-
USB_6_7_OC#	A38	B38	USB_4_5_OC#
USB6+	A37	B37	USB7+
USB6-	A36	B36	USB7-
THRMTRIP#	A35	B35	THRM#
NC	A34	B34	I2C_DATA
HAD_SDOOUT	A33	B33	I2C_CLK
HAD_BITCLK	A32	B32	SPKR
GND	A31	B31	GND
HDA_RST#	A30	B30	HDA_SDIO
HDA_SYNC	A29	B29	NC
(S)ATA_ACT#	A28	B28	NC
BATLOW#	A27	B27	WDT
USB_SSRX1+	A26	B26	USB_SSTX1+
USB_SSRX1-	A25	B25	USB_SSTX1-
SUS_S5#	A24	B24	PWR_OK
USB_SSRX0+	A23	B23	USB_SSTX0+
USB_SSRX0-	A22	B22	USB_SSTX0-
GND	A21	B21	GND

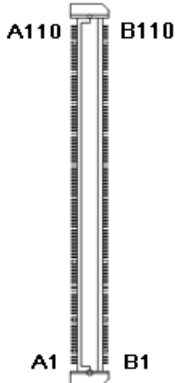
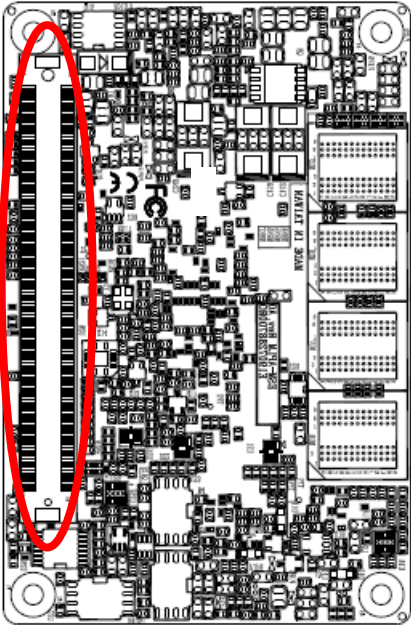

Signal	PIN	PIN	Signal
SATA0_RX-	A20	B20	SATA1_RX-
SATA0_RX+	A19	B19	SATA1_RX+
PCH_SLP_S4#	A18	B18	SUS_STAT#
SATA0_TX-	A17	B17	SATA1_TX-
SATA0_TX+	A16	B16	SATA1_TX+
SUS_S3#	A15	B15	SMB_ALERT#
GBE0_CTREF	A14	B14	SMB_SDA_S5
GBE0_MDI0+	A13	B13	SMB_SCL_S5
GBE0_MDI0-	A12	B12	PWRBTN#
GND	A11	B11	GND
GBE0_MDI1+	A10	B10	LPC_CLK
GBE0_MDI1-	A9	B9	NC
GBE0_LINK#	A8	B8	NC
GBE0_MDI2+	A7	B7	LPC_AD3
GBE0_MDI2-	A6	B6	LPC_AD2
GBE0_LINK1000#	A5	B5	LPC_AD1
GBE0_LINK100#	A4	B4	LPC_AD0
GBE0_MDI3+	A3	B3	LPC_FRAME#
GBE0_MDI3-	A2	B2	GBE0_ACT#
GND	A1	B1	GND

### 2.3.2.1 Signal Description – COM Express Connector 1 (CN1A)

#### 2.3.2.1.1 Audio Signals

Signal	Signal Description
HDA_SYNC	HD Audio Sync
HDA_RST#	HD Audio Reset

#### 2.3.2.1.2 Gigabit Ethernet Signals

Signal	Signal Description																				
GBE0_MD[0:3] +/-	Gigabit Ethernet Controller 0: Media Dependent Interface Differential Pairs 0,1,2,3. The MDI can operate in 1000, 100 and 10 Mbit / sec modes. Some pairs are unused in some modes, per the following:																				
	<table border="1"> <thead> <tr> <th></th> <th>1000B-T</th> <th>100B-T</th> <th>10B-T</th> </tr> </thead> <tbody> <tr> <td>MDI[0] +/-</td> <td>B1_DA+</td> <td>TX+/-</td> <td>TX+/-</td> </tr> <tr> <td>MDI[1] +/-</td> <td>B1_DB+</td> <td>RX+/-</td> <td>RX+/-</td> </tr> <tr> <td>MDI[2] +/-</td> <td>B1_DC+</td> <td>X</td> <td>X</td> </tr> <tr> <td>MDI[3] +/-</td> <td>B1_DD+</td> <td>X</td> <td>X</td> </tr> </tbody> </table>		1000B-T	100B-T	10B-T	MDI[0] +/-	B1_DA+	TX+/-	TX+/-	MDI[1] +/-	B1_DB+	RX+/-	RX+/-	MDI[2] +/-	B1_DC+	X	X	MDI[3] +/-	B1_DD+	X	X
		1000B-T	100B-T	10B-T																	
	MDI[0] +/-	B1_DA+	TX+/-	TX+/-																	
	MDI[1] +/-	B1_DB+	RX+/-	RX+/-																	
MDI[2] +/-	B1_DC+	X	X																		
MDI[3] +/-	B1_DD+	X	X																		
GBE0_ACT#	Gigabit Ethernet Controller 0 activity indicator, active low.																				
GBE0_Link#	Gigabit Ethernet Controller 0 link indicator, active low.																				
GBE0_Link100#	Gigabit Ethernet Controller 0 100 Mbit / sec link indicator, active low.																				
GBE0_Link1000#	Gigabit Ethernet Controller 0 1000 Mbit / sec link indicator, active low.																				

#### 2.3.2.1.3 PCI Express Signals

Signal	Signal Description
PCIE_TX[0:3] +/-	PCI Express Differential Transmit Pair 0-3
PCIE_RX[0:3] +/-	PCI Express Differential Receive Pair 0-3

#### 2.3.2.1.4 Flat Panel LVDS Signals

Signal	Signal Description
LVDS_BKLT_CTRL	Controls panel digital power.
LVDS_I2C_CLK	I2C clock output for LVDS display use.
LVDS_I2C_DAT	I2C data line for LVDS display use.
LVDS_VDD_EN	LVDS panel power enables.

2.3.2.1.5 LPC Signals

Signal	Signal Description
LPC_FRAME#	LPC frame indicates the start of an LPC cycle
LPC_AD[0:3]	LPC multiplexed address, command and data bus
LPC_CLKOUT1	LPC clock output - 33MHz nominal
LPC_SERIRQ	LPC serial interrupt

2.3.2.1.6 GPIO Signals

Signal	Signal Description
GPI[0:4]	General purpose input pins.
GPO[0:4]	General purpose output pins.

2.3.2.1.7 Power & System Management Signals

Signal	Signal Description
SUS_S3#	Indicates system is in Suspend to RAM state. Active low output.
BATLOW#	Indicates that external battery is low
PWRBTN#	Power button to bring system out of S5 (soft off), active on rising edge.
SMB_SCL_S5	System Management Bus bidirectional clock line.
SMB_SDA_S5	System Management Bus bidirectional data line.
SMB_ALERT#	System Management Bus Alert - input can be used to generate an SMI# (System Management Interrupt) or to wake the system.
SUS_STAT#	Indicates imminent suspend operation.
PWR_OK	Power OK from main power supply
SYS_RESET#	Reset button input. Active low input.
WAKE0#	PCI Express wake up signal.
WAKE1#	General purpose wake up signal.

## ESM-APLM User's Manual

### 2.3.2.1.8 SATA Signals

Signal	Signal Description
SATA[0:1]_TX +/-	Serial ATA Channel 0-1 transmit differential pair.
SATA[0:1]_RX +/-	Serial ATA Channel 0-1 receive differential pair.
ATA_ACT#	ATA (parallel and serial) activity indicator, active low.

### 2.3.2.1.9 USB Signals

Signal	Signal Description
USB[0:7] +/-	USB differential pairs, channels 0 through 7
USB_0_1_OC#	USB over-current sense, USB channels 0 and 1
USB_2_3_OC#	USB over-current sense, USB channels 2 and 3
USB_4_5_OC#	USB over-current sense, USB channels 4 and 5
USB_6_7_OC#	USB over-current sense, USB channels 6 and 7

### 2.3.2.1.10 I2C Signals

Signal	Signal Description
I2C_CLK	General purpose I2C port clock output.
I2C_DATA	General purpose I2C port data I/O line.

### 2.3.2.1.11 USB3.0 Signals

Signal	Signal Description
USB_SSTX[0:1]+ USB_SSTX[0:1]-	Additional transmit signal differential pairs for the SuperSpeed USB data path.
USB_SSRX[0:1]+ USB_SSRX[0:1]-	Additional receive signal differential pairs for the SuperSpeed USB data path.

### 2.3.2.1.12 DDI Signals

Signal	Signal Description
DDI0_PAIR[0:2]+ DDI0_PAIR[0:2]-	Digital Display Interface0 Pair[0:2] differential pairs
DDI0_DDC_AUX_SEL	Selects the function of DDI0_CTRLCLK_AUX+ and DDI0_CTRLDATA_AUX-. If this input is floating the AUX pair is used for the DP AUX+/- signals. If pulled-high the AUX pair contains the CRTCLK and CTRLDATA signals.
DDI0_CTRLCLK_AUX+	DP AUX+function if DDI0_DDC_AUX_SEL is no connect



	HDMI/DVI 12C CTRLCLK if DDI0_DDC_AUX_SEL is pulled high
DDI0_CTRLDATA_AUX-	DP AUX-function if DDI0_DDC_AUX_SEL is no connect HDMI/DVI 12C CTRLDATA if DDI0_DDC_AUX_SEL is pulled high
DDI0_HPD	Digital Display Interface Hot-Plug Detect

## 2.4 Installing Heatsink / Heat spreader

Heatsink

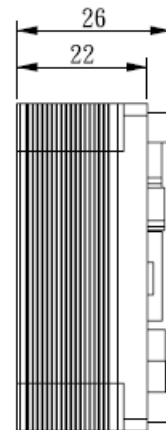
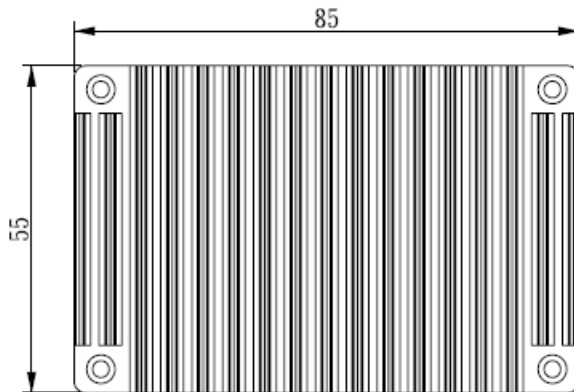
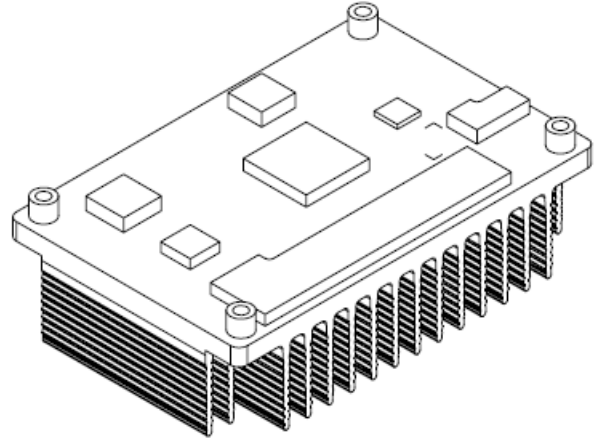
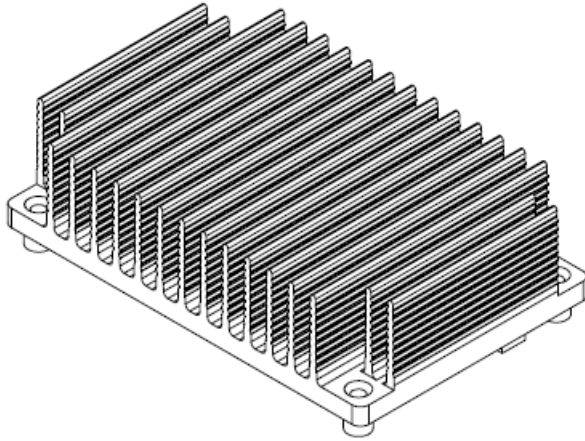

Heat spreader

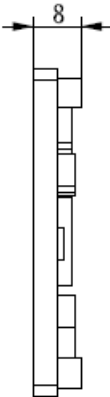
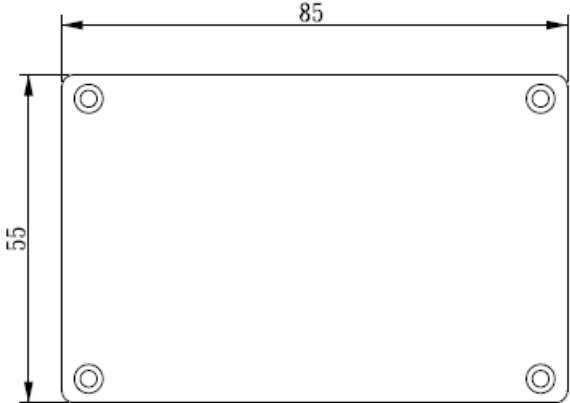
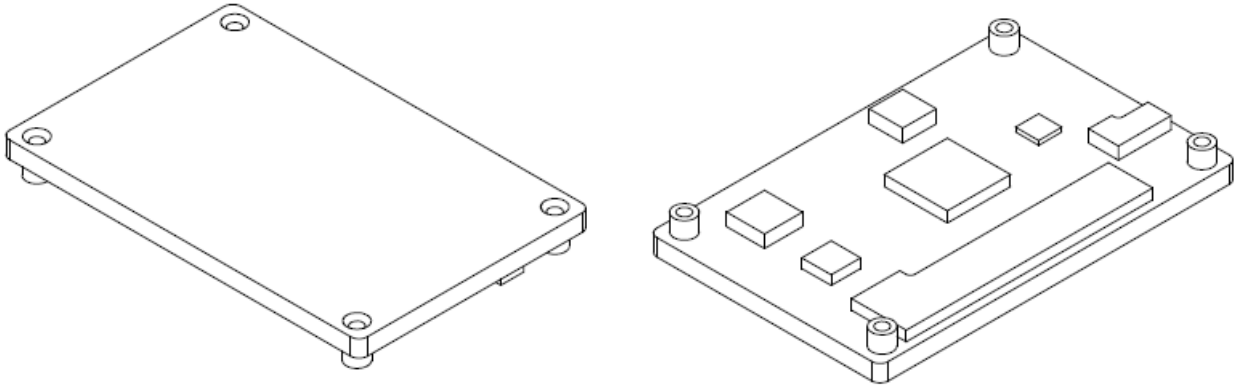

Heatsink

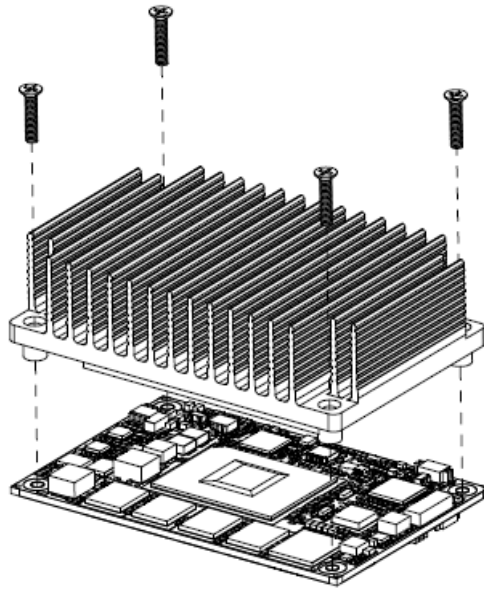

Heat spreader

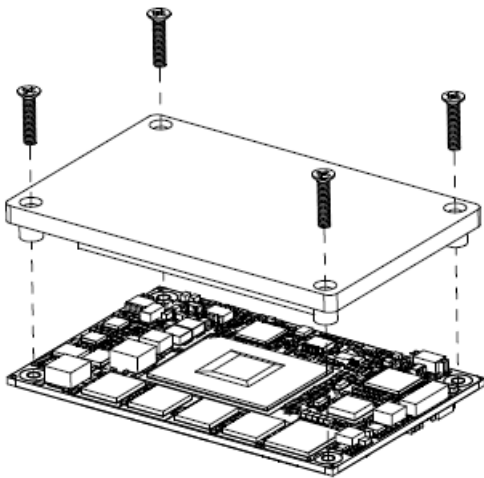

**Step1.** Using 4 screws (M2.5-12L) to lock the Heatsink/Heat spreader from PCB backside.

**Note:**

Screw Size/Q'TY

- M2.5-12L Ni\*4pcs

# 3. BIOS Setup

---

### 3.1 Introduction

The BIOS setup program allows users to modify the basic system configuration. In this following chapter will describe how to access the BIOS setup program and the configuration options that may be changed.

### 3.2 Starting Setup

AMI BIOS™ is immediately activated when you first power on the computer. The BIOS reads the system information contained in the NVRAM and begins the process of checking out the system and configuring it. When it finishes, the BIOS will seek an operating system on one of the disks and then launch and turn control over to the operating system.

While the BIOS is in control, the Setup program can be activated in one of two ways:

By pressing <F2> or <Del> immediately after switching the system on, or

By pressing the <F2> or <Del> key when the following message appears briefly at the left-top of the screen during the POST (Power On Self Test).

**Press <F2> or <Del> to enter SETUP**

If the message disappears before you respond and you still wish to enter Setup, restart the system to try again by turning it OFF then ON or pressing the "RESET" button on the system case. You may also restart by simultaneously pressing <Ctrl>, <Alt>, and <Delete> keys.

### 3.3 Using Setup

In general, you use the arrow keys to highlight items, press <Enter> to select, use the PageUp and PageDown keys to change entries, press <F1> for help and press <Esc> to quit. The following table provides more detail about how to navigate in the Setup program using the keyboard.

Button	Description
↑	Move to previous item
↓	Move to next item
←	Move to the item in the left hand
→	Move to the item in the right hand
Esc key	Main Menu -- Quit and not save changes into NVRAM Status Page Setup Menu and Option Page Setup Menu -- Exit current page and return to Main Menu
+ key	Increase the numeric value or make changes
- key	Decrease the numeric value or make changes
F1 key	General help, only for Status Page Setup Menu and Option Page Setup Menu
F2 key	Previous Values
F3 key	Optimized defaults
F4 key	Save & Exit Setup

- **Navigating Through The Menu Bar**

Use the left and right arrow keys to choose the menu you want to be in.



**Note:** Some of the navigation keys differ from one screen to another.

- **To Display a Sub Menu**

Use the arrow keys to move the cursor to the sub menu you want. Then press <Enter>. A “➤” pointer marks all sub menus.

### 3.4 Getting Help

Press F1 to pop up a small help window that describes the appropriate keys to use and the possible selections for the highlighted item. To exit the Help Window press <Esc> or the F1 key again.

### 3.5 In Case of Problems

If, after making and saving system changes with Setup, you discover that your computer no longer is able to boot, the BIOS supports an override to the NVRAM settings which resets your system to its defaults.

The best advice is to only alter settings which you thoroughly understand. To this end, we strongly recommend that you avoid making any changes to the chipset defaults. These defaults have been carefully chosen by both your systems manufacturer to provide the absolute maximum performance and reliability. Even a seemingly small change to the chipset setup has the potential for causing you to use the override.



### 3.6 BIOS setup

Once you enter the Aptio Setup Utility, the Main Menu will appear on the screen. The Main Menu allows you to select from several setup functions and exit choices. Use the arrow keys to select among the items and press <Enter> to accept and enter the sub-menu.

#### 3.6.1 Main Menu

This section allows you to record some basic hardware configurations in your computer and set the system clock.

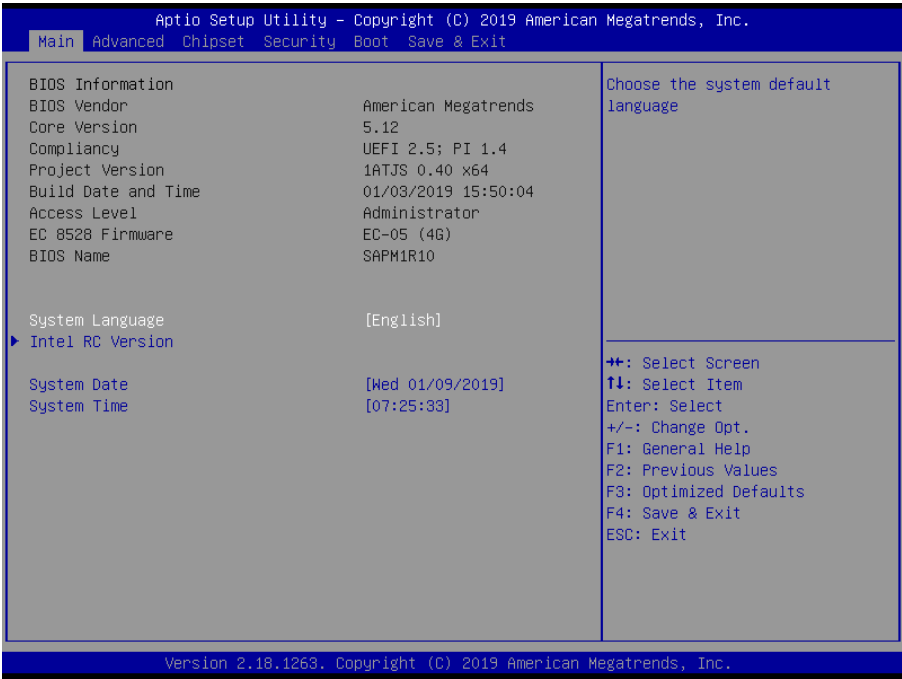

**Note:**

(4G): Depends on H/W Option, it means Memory size on board. There may (2G)/(4G)/(8G).

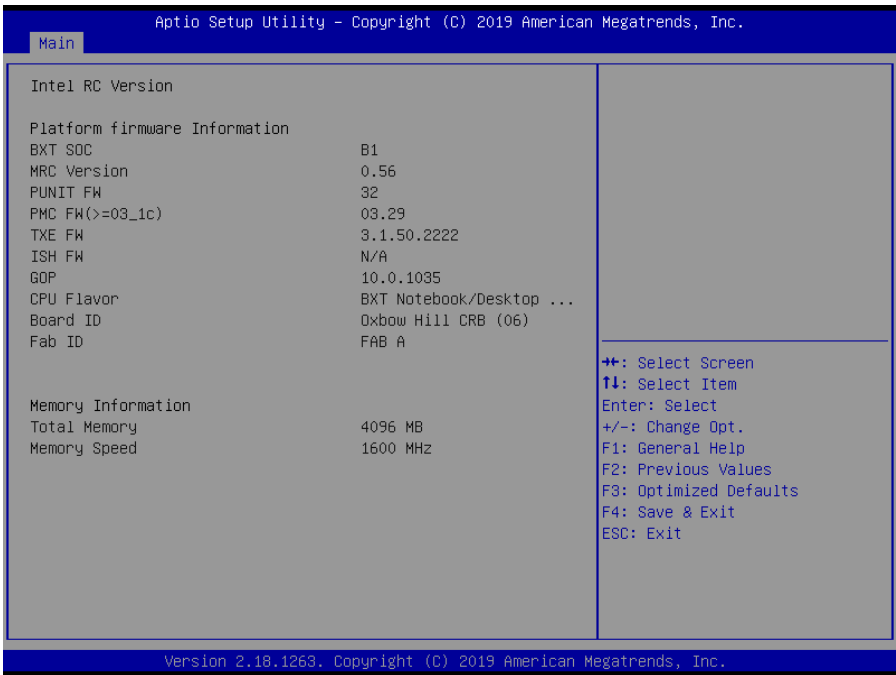

## ESM-APLM User's Manual

### 3.6.1.1 System Language

This option allows choosing the system default language.

### 3.6.1.2 System Date

Use the system date option to set the system date. Manually enter the day, month and year.

### 3.6.1.3 System Time

Use the system time option to set the system time. Manually enter the hours, minutes and seconds.



**Note:** The BIOS setup screens shown in this chapter are for reference purposes only, and may not exactly match what you see on your screen.

Visit the Avalue website ([www.avalue.com.tw](http://www.avalue.com.tw)) to download the latest product and BIOS information.

## 3.6.2 Advanced Menu

This section allows you to configure your CPU and other system devices for basic operation through the following sub-menus.

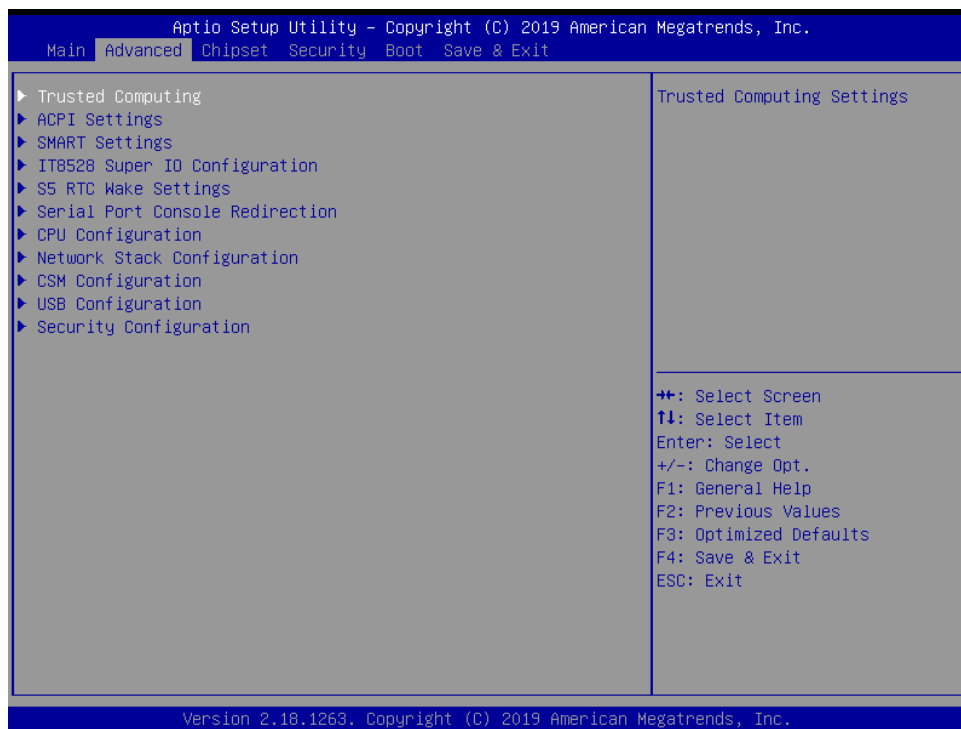

3.6.2.1 Trusted Computing

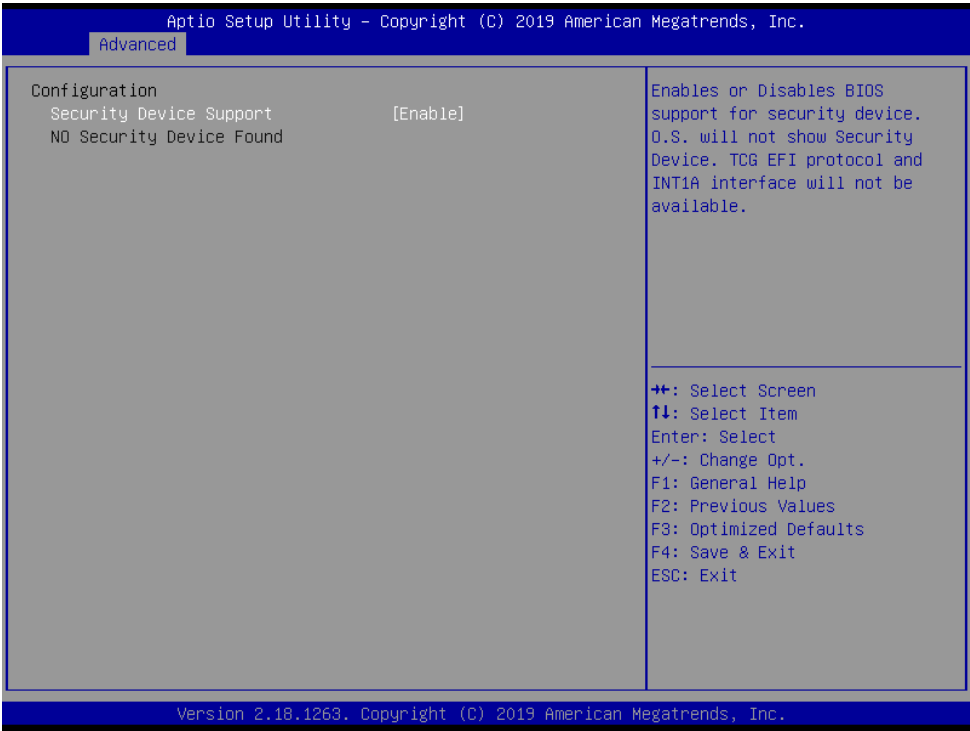

Item	Options	Description
Security Device Support	Disable, Enable[Default]	Enables or Disables BIOS support for security device. O.S. will not show Security Device. TCG EFI protocol and INT1A interface will not be available.

3.6.2.2 APCI Settings

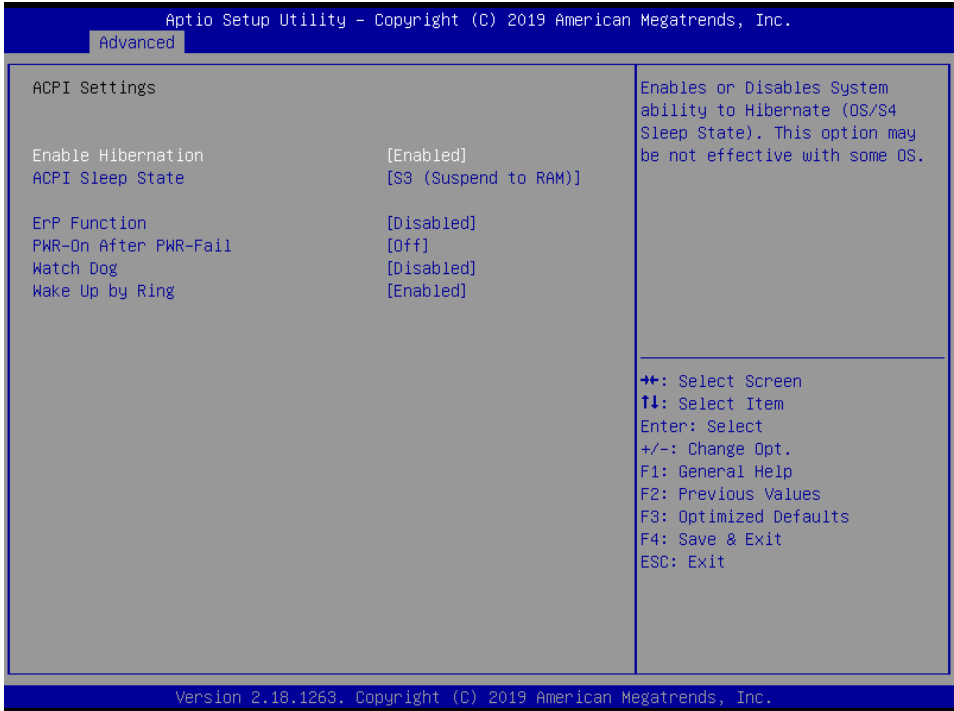

## ESM-APLM User's Manual

Item	Options	Description
<b>Enable Hibernation</b>	Disabled Enabled[Default],	Enables or Disables System ability to Hibernate (OS/S4 Sleep State). This option may be not effective with some OS.
<b>ACPI Sleep State</b>	Suspend Disabled, S3 (Suspend to RAM) [Default]	Select the highest ACPI sleep state the system will enter when the SUSPEND button is pressed.
<b>ErP Function</b>	Disabled[Default], Enabled	ErP Function (Deep S5).
<b>Pwr-On After PWR-Fail</b>	Off[Default] On Last state	AC loss resume.
<b>Watch Dog</b>	Disabled[Default], 30 sec 40 sec 50 sec 1 min 2 min 10 min 30 min	Select WatchDog.
<b>Wake Up By Ring</b>	Disabled Enabled[Default],	Wake Up by Ring from S3/S4/S5.

### 3.6.2.3 SMART Settings

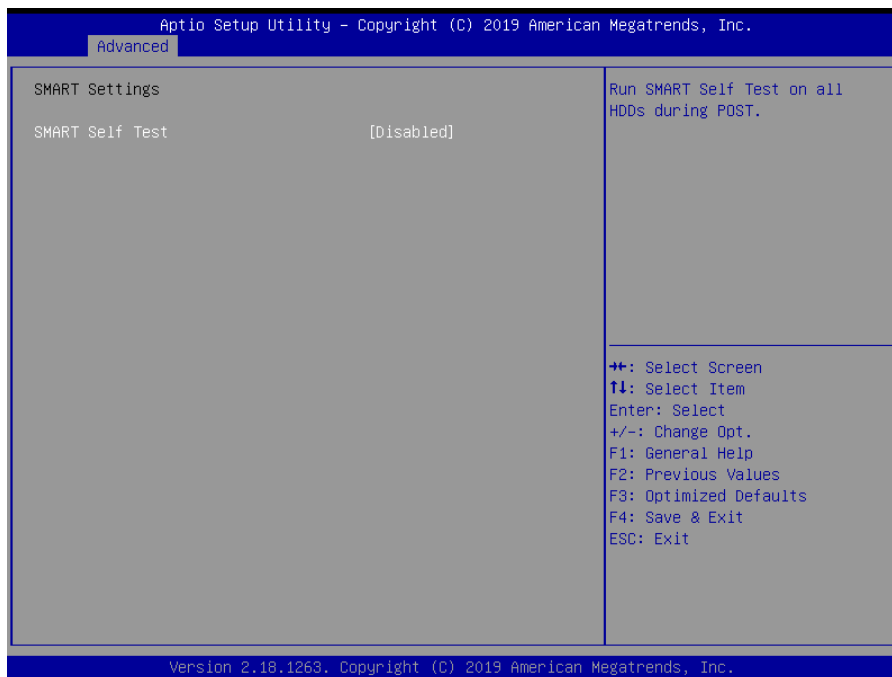

Item	Options	Description
<b>SMART Self Test</b>	Disabled[Default] Enabled,	Run SMART Self Test on all HDDs during POST.

**3.6.2.4 IT8528 Super IO Configuration**

You can use this item to set up or change the IT8528 Super IO configuration for serial ports. Please refer to 3.6.2.4.1~ 3.6.2.4.2 for more information.

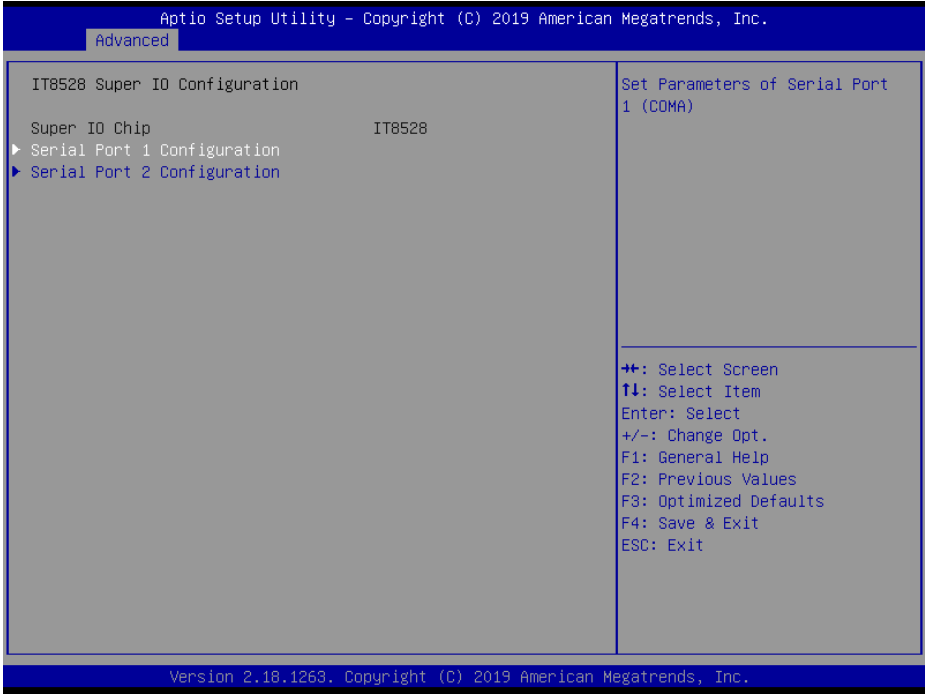

Item	Description
Serial Port 1 Configuration	Set Parameters of Serial Port 1 (COMA).
Serial Port 2 Configuration	Set Parameters of Serial Port 2 (COMB).

**3.6.2.4.1 Serial Port 1 Configuration**

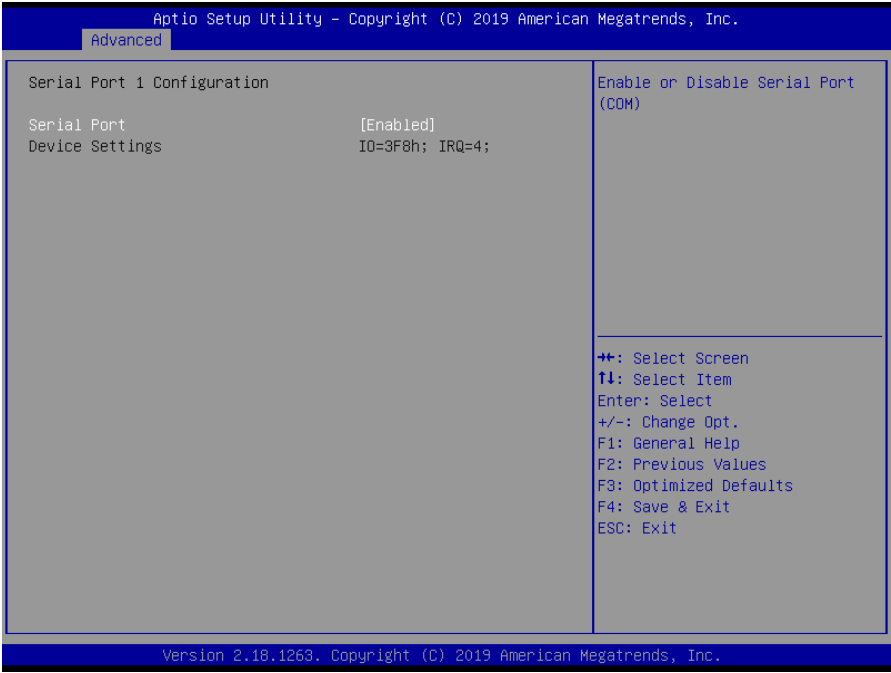

# ESM-APLM User's Manual

Item	Option	Description
Serial Port	Enabled[Default], Disabled	Enable or Disable Serial Port (COM).

**Note:**

Only TX / RX signal, H/W Option function (optional).

### 3.6.2.4.2 Serial Port 2 Configuration

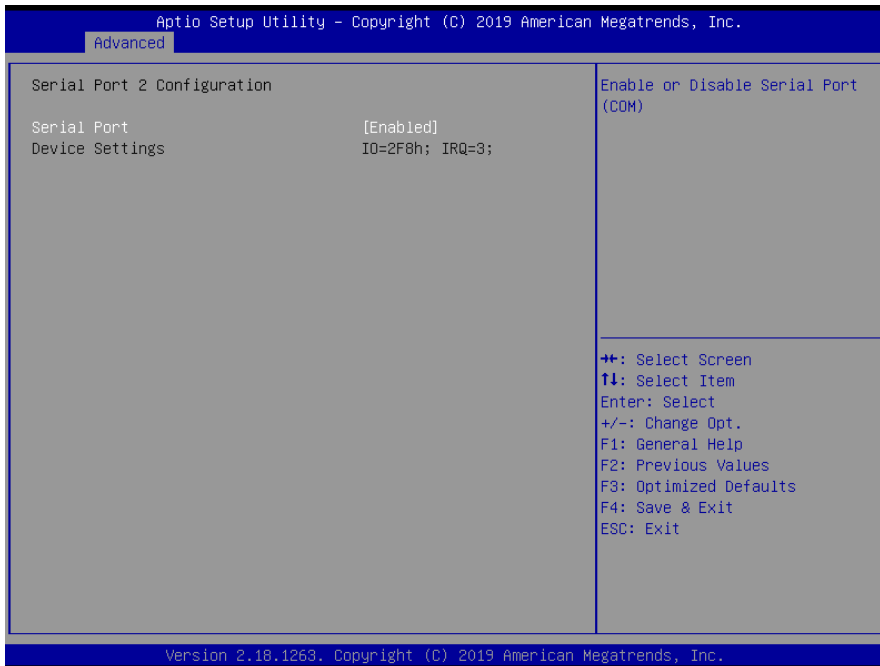

Item	Option	Description
Serial Port	Enabled[Default], Disabled	Enable or Disable Serial Port (COM).

**Note:**

Only TX / RX signal, H/W Option function (optional).

3.6.2.5 S5 RTC Wake Settings

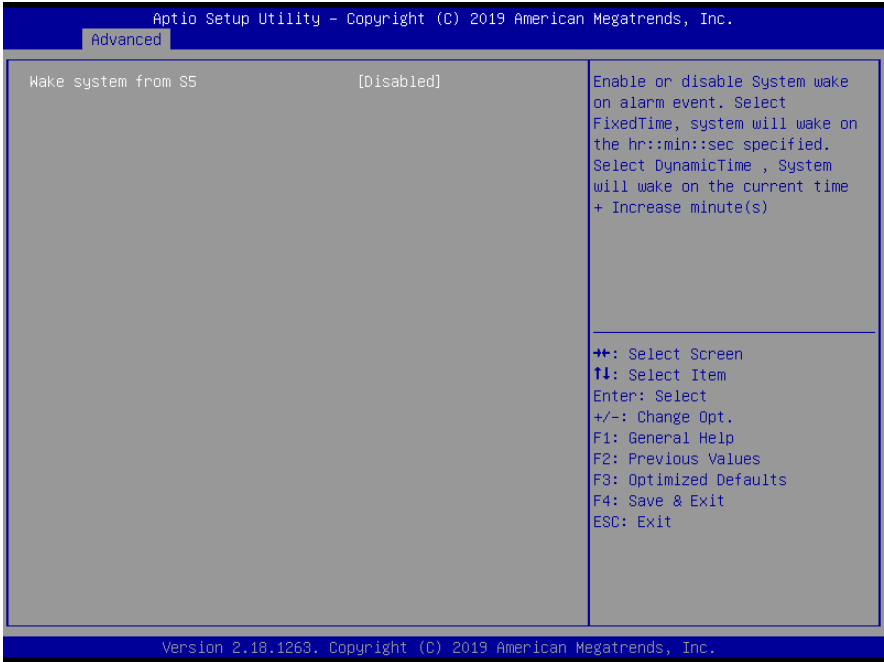

Item	Options	Description
Wake system from S5	Disabled[Default], Fixed Time Dynamic Time	Enable or disable System wake on alarm event. Select FixedTime, system will wake on the hr::min::sec specified. Select DynamicTime, System will wake on the current time + Increase minute(s).

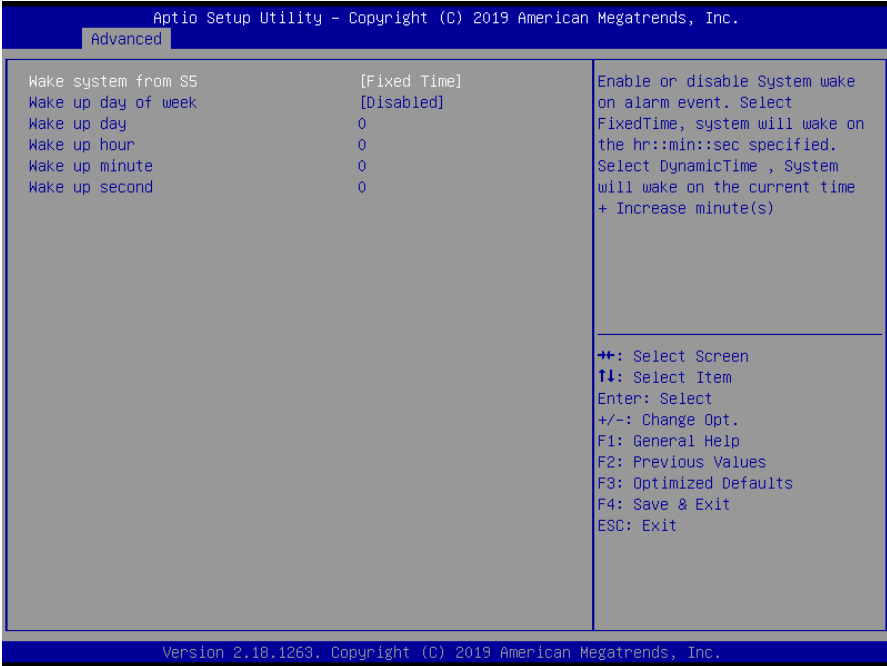

Item	Options	Description
Wake system from S5	Disabled, Fixed Time[Default] Dynamic Time	Enable or disable System wake on alarm event. Select Fixed Time, system will wake on the hr::min::sec specified. Select Dynamic Time, System will wake on

## ESM-APLM User's Manual

		the current time + Increase minute(s).
<b>Wake up day of week</b>	Disabled[Default] Monday-Friday Monday-Saturday	Wake up day of week. (Monday-Friday) or (Monday-Saturday).
<b>Wake up day</b>	1-31	Select 0 for daily system wake up 1-31 for which day of the month that you would like the system to wake up.
<b>Wake up hour</b>	0-23	Select 0-23 For example enter 3 for 3am and 15 for 3pm.
<b>Wake up minute</b>	0-59	Select 0-59 For Minute.
<b>Wake up second</b>	0-59	Select 0-59 For Second.

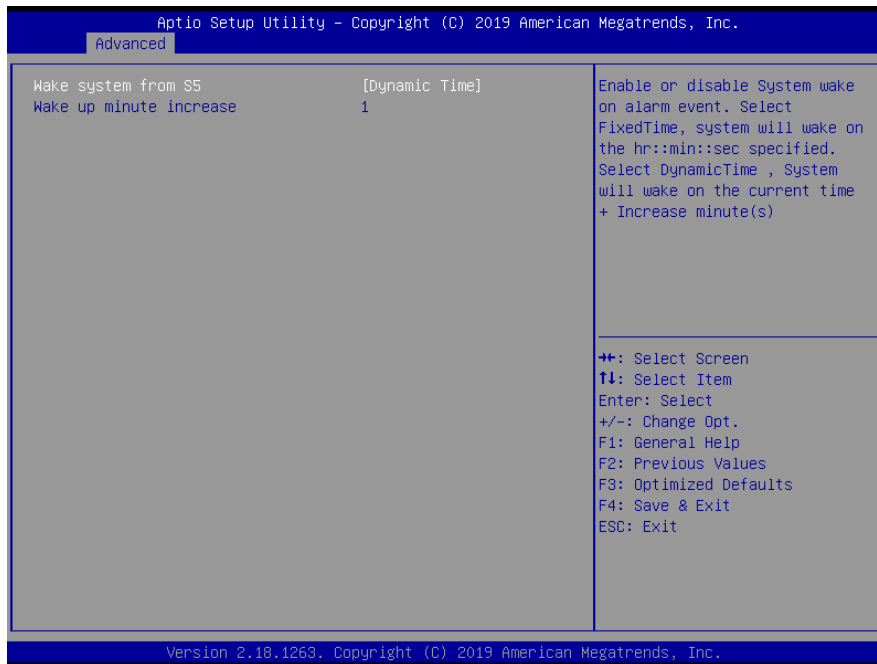

Item	Options	Description
<b>Wake system from S5</b>	Disabled, Fixed Time Dynamic Time[Default]	Enable or disable System wake on alarm event. Select Fixed Time, system will wake on the hr::min::sec specified. Select Dynamic Time, System will wake on the current time + Increase minute(s).
<b>Wake up minute increase</b>	1-5	1-5.



3.6.2.6 Serial Port Console Redirection

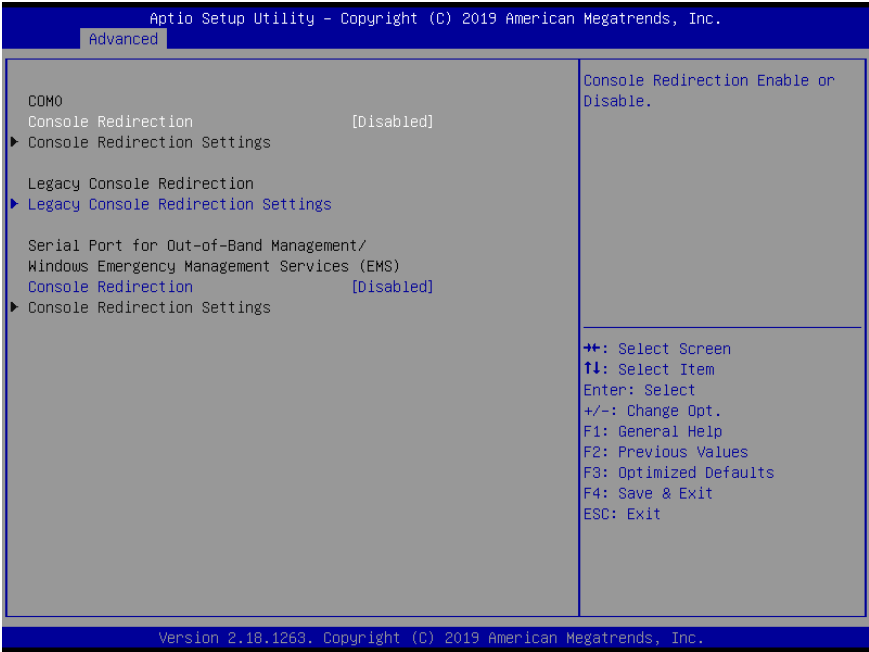

Note:

This function depends on Serial Port 1 H/W Option.

Item	Options	Description
Console Redirection	Disabled[Default], Enabled	Console Redirection Enable or Disable.
Console Redirection	Disabled[Default], Enabled	Console Redirection Enable or Disable.

3.6.2.6.1 COM0

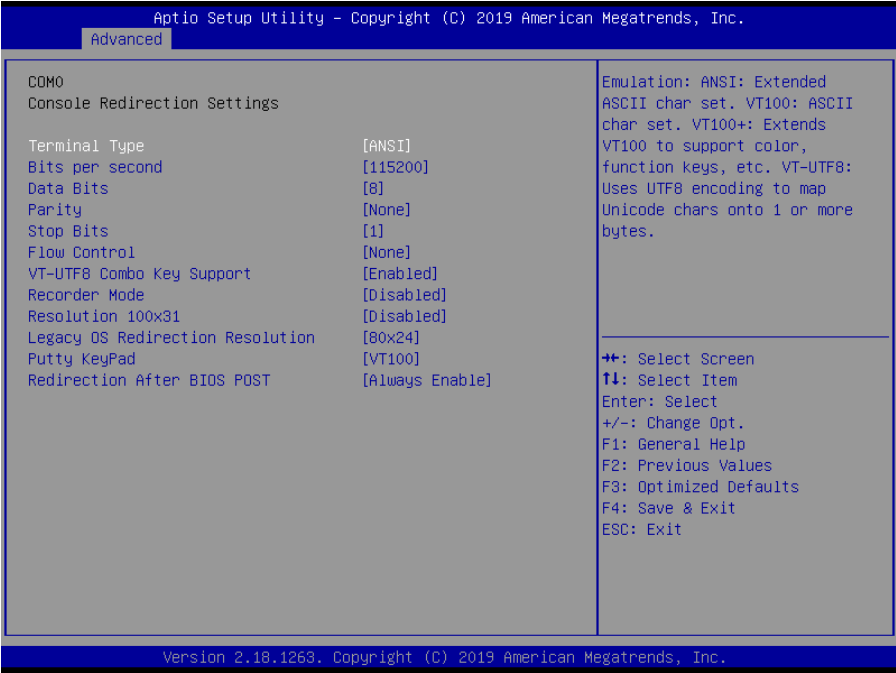

## ESM-APLM User's Manual

Item	Option	Description
<b>Terminal Type</b>	VT100 VT100+ VT-UTF8 ANSI[Default]	Emulation: ANSI: Extender ASCII char set. VT100: ASCII char set. VT100+:Extends VT100 to support color, function keys, etc. VT-UTF8: Uses UTF8 encoding to map Unicode chars onto 1 or more bytes.
<b>Bits per second</b>	9600 19200 38400 57600 115200[Default]	Select serial port transmission speed. The speed must be matched on the other side. Long or noisy lines may require lower speeds.
<b>Data Bits</b>	7 8[Default]	Data Bits.
<b>Parity</b>	None[Default] Even Odd Mark Space	A parity bit can be sent with the data bits to detect some transmission errors. Even: parity bit is 0 if the num of 1's in the data bits is even. Odd: parity bit is 0 if num of 1's in the data bits is odd. Mark: parity bit is always 1. Space: Parity bit is always 0. Mark and Space Parity do not allow for error detection. They can be used as an additional data bit.
<b>Stop Bits</b>	1[Default] 2	Stop bits indicate the end of a serial data packet. (A start bit indicates the beginning). The standard setting is 1 stop bit. Communication with slow devices may require more than 1 stop bit.
<b>Flow Control</b>	None Hardware RTS/CTS[Default]	Flow control can prevent data loss from buffer overflow. When sending data, if the receiving buffers are full, a 'stop' signal can be sent to stop the data flow. Once the buffers are empty, a 'start' signal can be sent to re-start the flow. Hardware flow control uses two wires to send start/stop signals.
<b>VT-UTF8 Combo Key Support</b>	Disabled Enabled[Default]	Enable VT-UTF8 Combination Key Support for ANSI/VT100 terminals.
<b>Recorder Mode</b>	Disabled[Default] Enabled	With this mode enabled only text will be sent. This is to capture Terminal data.
<b>Resolution 100x31</b>	Disabled[Default] Enabled	Enables or disables extended terminal resolution.
<b>Legacy OS Redirection Resolution</b>	80x24[Default] 80x25	On Legacy OS, the Number of Rows and Columns supported redirection.
<b>Putty KeyPad</b>	VT100[Default] Intel Linux XTERMR6 SCO ESCN VT400	Select FunctionKey and KeyPad on Putty.
<b>Redirection After BIOS POST</b>	Always Enable[Default] BootLoader	When Bootloader is selected, then Legacy Console Redirection is disabled before booting to legacy OS. When Always Enable

		is selected, then Legacy Console Redirection is enabled for legacy OS. Default setting for this option is set to Always Enable.
--	--	---

3.6.2.6.2 Legacy Console Redirection Settings

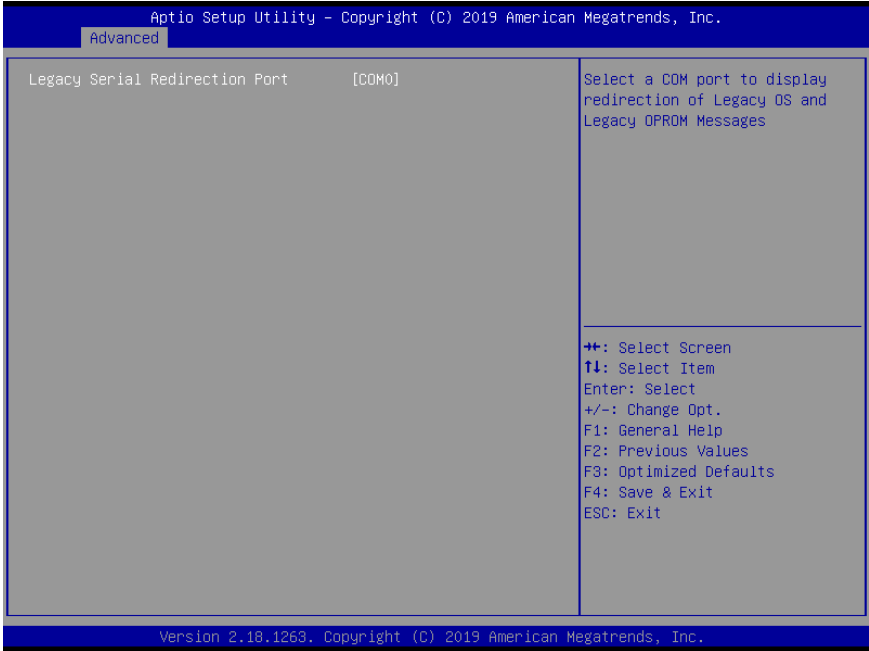

Item	Option	Description
Legacy Serial Redirection Port	COM0[Default],	Select a COM port to display redirection of Legacy OS and Legacy OPROM Messages.

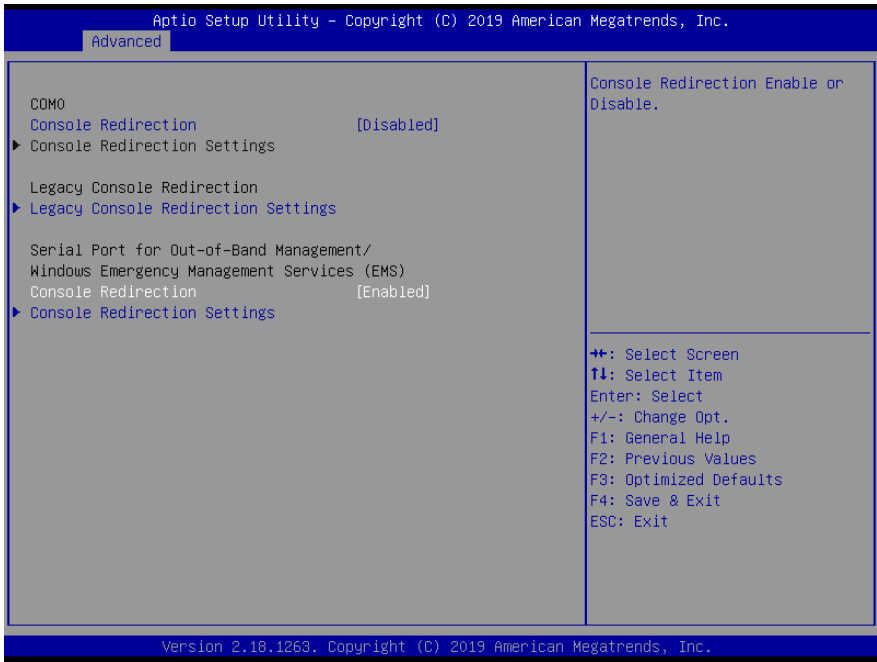

Item	Options	Description
Console Redirection	Disabled[Default], Enabled	Console Redirection Enable or Disable.
Console Redirection	Disabled, Enabled[Default]	Console Redirection Enable or Disable.

### 3.6.2.6.3 Console Redirection Settings

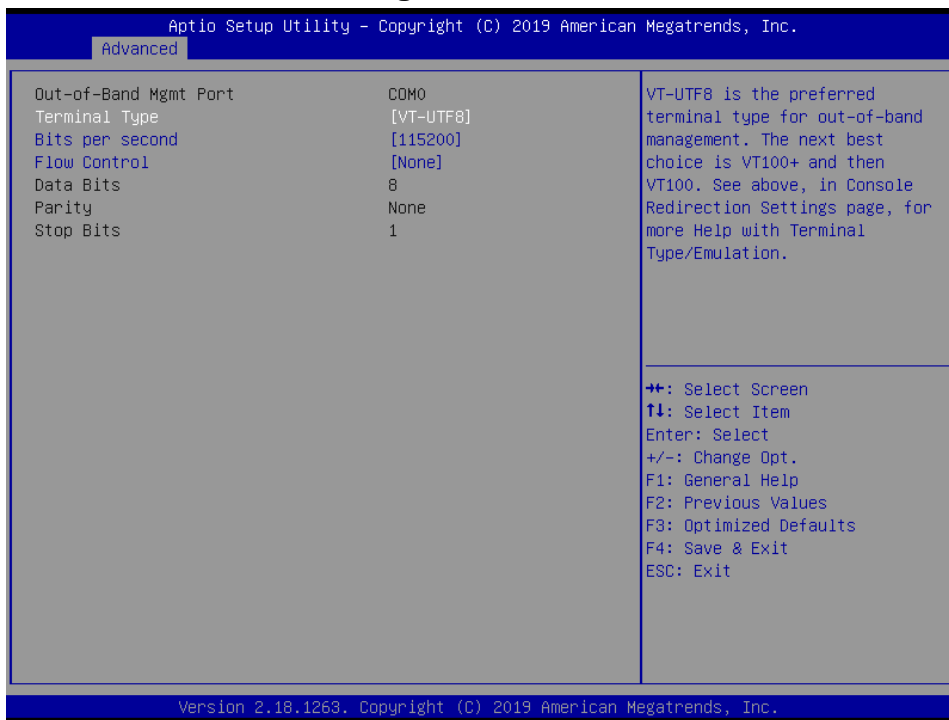

Item	Option	Description
Terminal Type	VT100 VT100+ VT-UTF8[Default], ANSI	VT-UTF8 is the preferred terminal type for out-of-band management. The next best choice is VT100+ and then VT100+. See above, in Console Redirection Settings page, for more Help with Terminal Type/Emulation.
Bits per second	9600 19200 57600 115200[Default]	Select serial port transmission speed. The speed must be matched on the other side. Long or noisy lines may require lower speeds.
Flow Control	None[Default] Hardware RTS/CTS Software Xon/Xoff	Flow control can prevent data loss from buffer overflow. When sending data, if the receiving buffers are full, a 'stop' signal can be sent to stop the data flow. Once the buffers are empty, a 'start' signal can be sent to re-start the flow. Hardware flow control uses two wires to send start/stop signals.

3.6.2.7 CPU Configuration

Use the CPU configuration menu to view detailed CPU specification and configure the CPU.

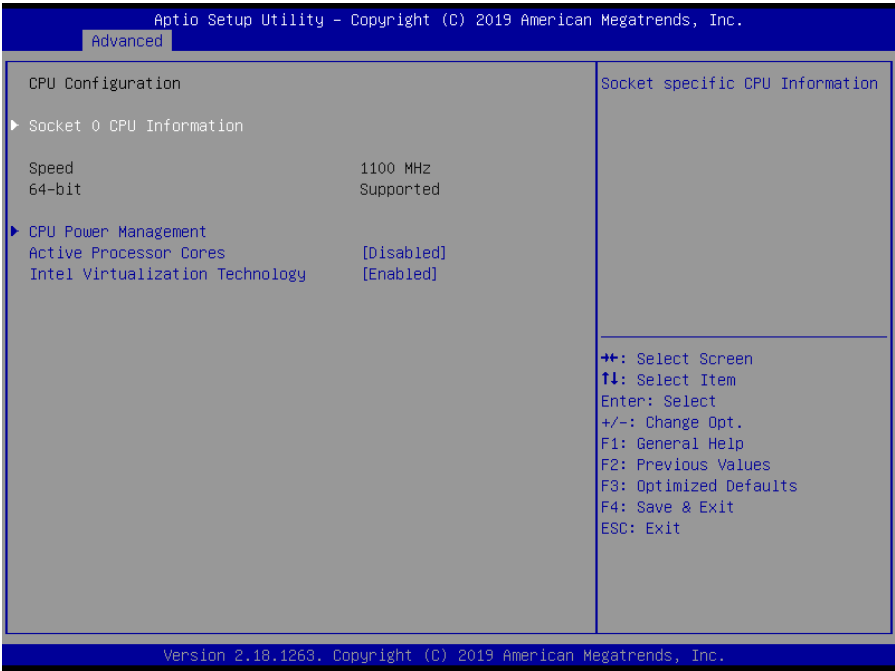

Item	Options	Description
Active Processor Cores	Disabled[Default] Enabled	Number of cores to enable in each processor package.
Intel Virtualization Technology	Disabled Enabled[Default]	When enabled, a VMM can utilize the additional hardware capabilities provided by Vanderpool Technology.

3.6.2.7.1 Socket 0 CPU Information

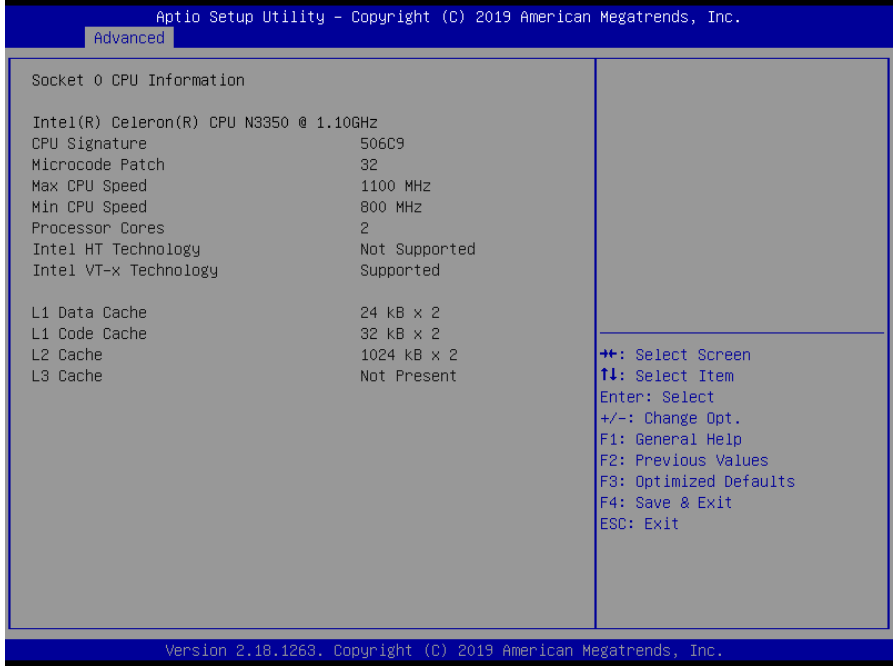

3.6.2.7.2 CPU Power Management Configuration



Item	Option	Description
<b>EIST</b>	Disabled Enabled[ <b>Default</b> ]	Enable/Disable Intel SpeedStep.
<b>Turbo Mode</b>	Disabled Enabled[ <b>Default</b> ]	Turbo Mode.
<b>C-States</b>	Disabled Enabled[ <b>Default</b> ]	Enable/Disable C States.
<b>Enhanced C-states</b>	Disabled Enabled[ <b>Default</b> ]	Enable/Disable C1E. When enabled, CPU will switch to minimum speed when all cores enter C-State.
<b>Max Core C State</b>	Fused value[ <b>Default</b> ] Core C10 Core C9 Core C8 Core C7 Core C6 Core C1 Unlimited	This option controls the Max Core C State that cores will support.
<b>C-State Auto Demotion</b>	Disabled C1[ <b>Default</b> ]	Configure C-State Auto Demotion.
<b>C-State Un-demotion</b>	Disabled C1[ <b>Default</b> ]	Configure C-State Un-demotion.

3.6.2.8 Network Stack Configuration

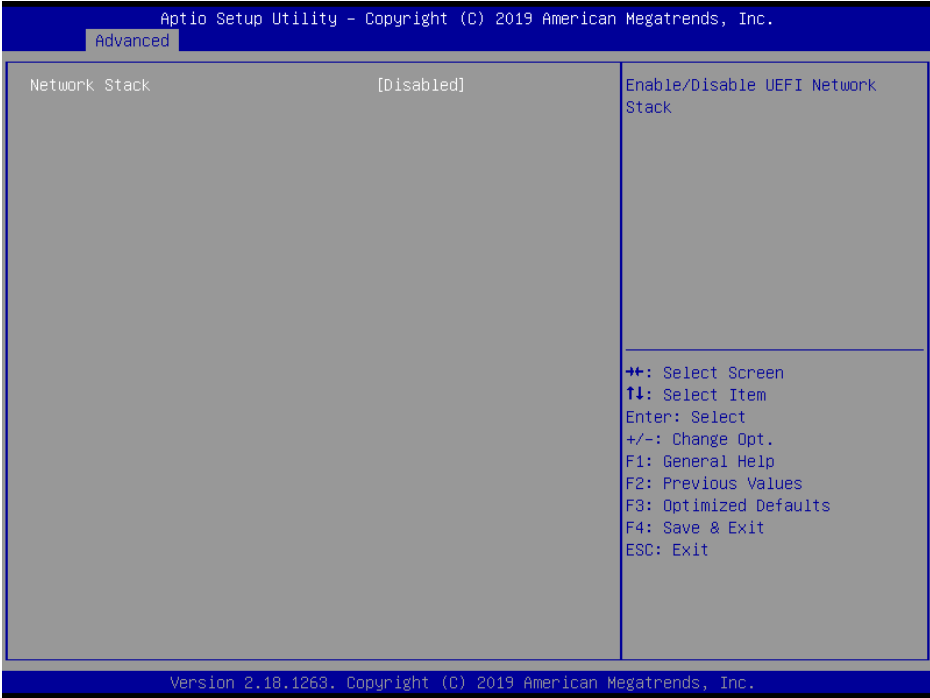

Item	Options	Description
<b>Network Stack</b>	Enabled Disabled[Default]	Enable/Disable UEFI Network Stack.

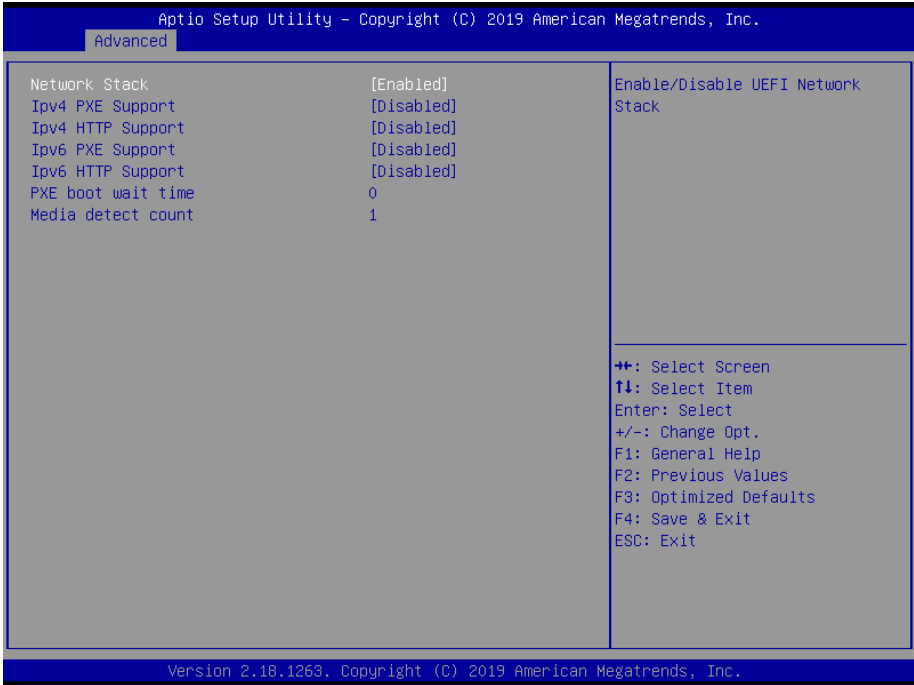

Item	Options	Description
<b>Network Stack</b>	Enabled[Default] Disabled	Enable/Disable UEFI Network Stack.
<b>Ipv4 PXE Support</b>	Enabled	Enable Ipv4 PXE Boot Support. If disabled IPV4

## ESM-APLM User's Manual

	Disabled[Default]	PXE boot option will not be created.
<b>Ipv4 HTTP Support</b>	Enabled Disabled[Default]	Enable Ipv4 HTTP Boot Support. If disabled IPV4 HTTP boot option will not be created.
<b>Ipv6 PXE Support</b>	Enabled Disabled[Default]	Enable Ipv6 PXE Boot Support. If disabled IPV6 PXE boot option will not be created.
<b>Ipv6 HTTP Support</b>	Enabled Disabled[Default]	Enable Ipv6 HTTP Boot Support. If disabled IPV4 HTTP boot option will not be created.
<b>PXE boot wait time</b>	0	Wait time to press ESC key to abort the PXE boot.
<b>Media detect count</b>	1	Number of times presence of media will be checked.

### 3.6.2.9 CSM Configuration



Item	Options	Description
<b>CSM Support</b>	Enabled Disabled[Default]	Enable/Disable CSM Support.



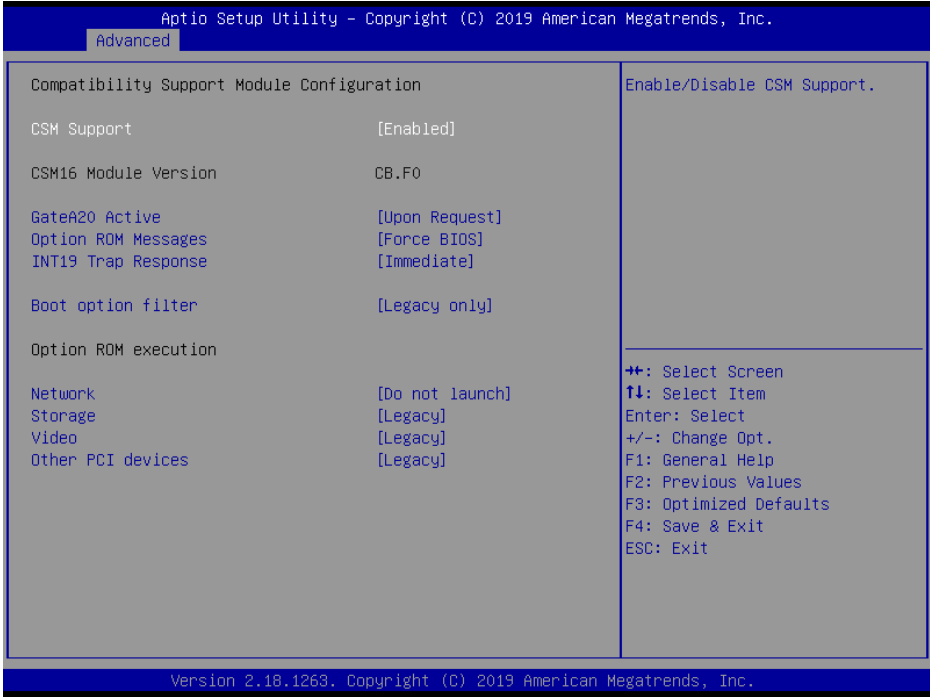

When the CSM Support is Enabled

Item	Options	Description
GateA20 Active	Upon Request[Default] Always	UPON REQUEST- GA20 can be disabled using BIOS services. ALWAYS – do not allow disabling GA20; this option is useful when any RT code is executed above 1MB.
Option ROM Messages	Force BIOS[Default] Keep Current	Set display mode for Option ROM.
INT19 Trap Response	Immediate[Default] Postponed	BIOS reaction on INT19 trapping by Option ROM: IMMEDIATE – execute the trap right away; POSTPONED – execute the trap during legacy boot.
Boot Option filter	UEFI and Legacy Legacy only[Default] UEFI only	This option controls Legacy/UEFI ROMs priority.
Network	Do not launch[Default] UEFI Legacy	Controls the execution of UEFI and Legacy PXE OpROM.
Storage	Do not launch UEFI Legacy[Default]	Controls the execution of UEFI and Legacy Storage OpROM.
Video	Do not launch UEFI Legacy[Default]	Controls the execution of UEFI and Legacy Video OpROM.
Other PCI devices	Do not launch UEFI Legacy[Default]	Determines OpROM execution policy for devices other than Network, Storage, or Video.

# ESM-APLM User's Manual

## 3.6.2.10 USB Configuration

The USB Configuration menu helps read USB information and configures USB settings.

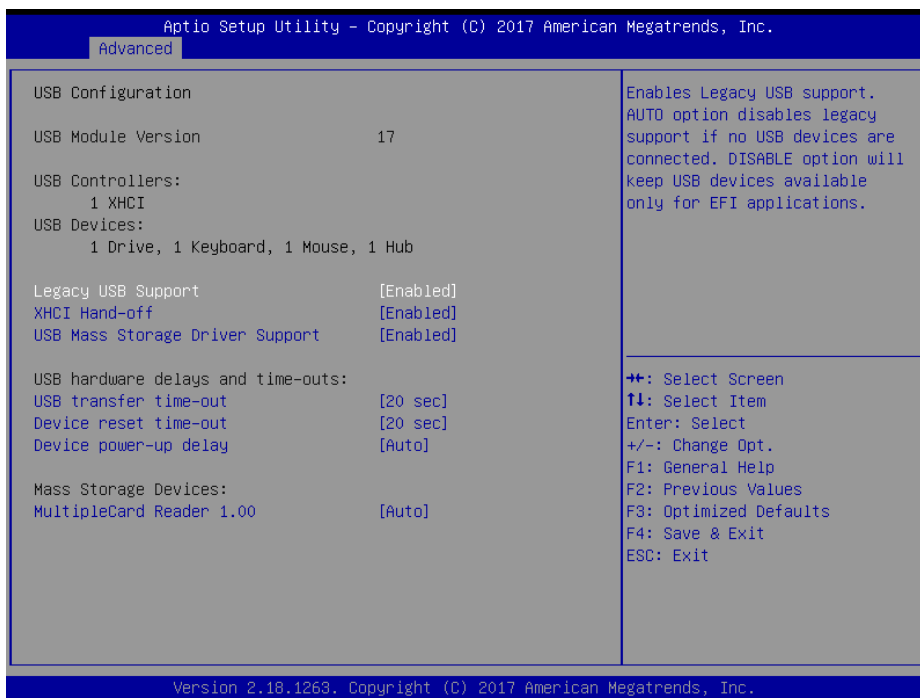

Item	Options	Description
<b>Legacy USB Support</b>	Enabled[Default] Disabled Auto	Enables Legacy USB support. AUTO option disables legacy support if no SUB devices are connected. DISABLE option will keep USB devices available only for EFI applications.
<b>XHCI Hand-off</b>	Enabled[Default] Disabled	This is a workaround for Oses without XHCI hand-off support. The XHCI ownership change should be claimed by XHCI driver.
<b>USB Mass Storage Driver Support</b>	Enabled[Default] Disabled	Enable/Disable USB Mass Storage Driver Support.
<b>USB transfer time-out</b>	1 sec 5 sec 10 sec 20 sec[Default]	The time-out value for Control, Bulk, and Interrupt transfers.
<b>Device reset time-out</b>	10 sec 20 sec[Default] 30 sec 40 sec	USB mass storage device Start Unit command time-out.
<b>Device power-up delay</b>	Auto[Default] Manual	Maximum time the device will take before it properly reports itself to the Host Controller. 'Auto' uses default value: for a Root port it is 100ms, for a Hub port the delay is taken form Hub descriptor.
<b>Mass Storage Devices</b>	Auto[Default] Floppy Forced FDD Hard Disk CD-ROM	Mass storage device emulation type. 'AUTO' enumerates devices according to their media format. Optical drives are emulated as 'CDROM', drives with no media will be emulated according to a drive type.

3.6.2.11 Security Configuration

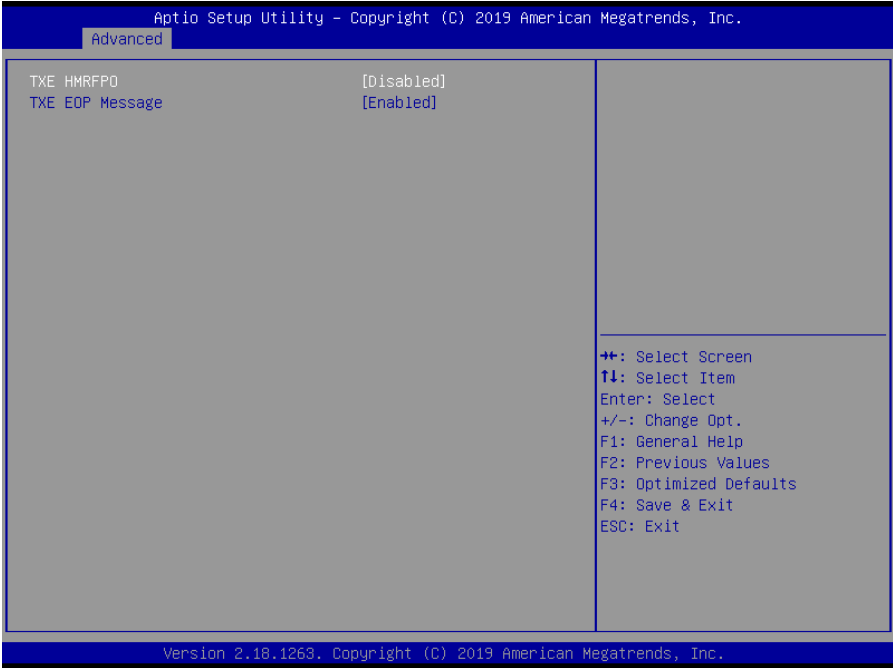

Item	Options	Description
TXE HMRFP0	Enabled Disabled <b>[Default]</b>	TXE HMRFP0.
TXE EOP Message	Enabled <b>[Default]</b> Disabled	Send EOP Message Before Enter OS.

# ESM-APLM User's Manual

## 3.6.3 Chipset

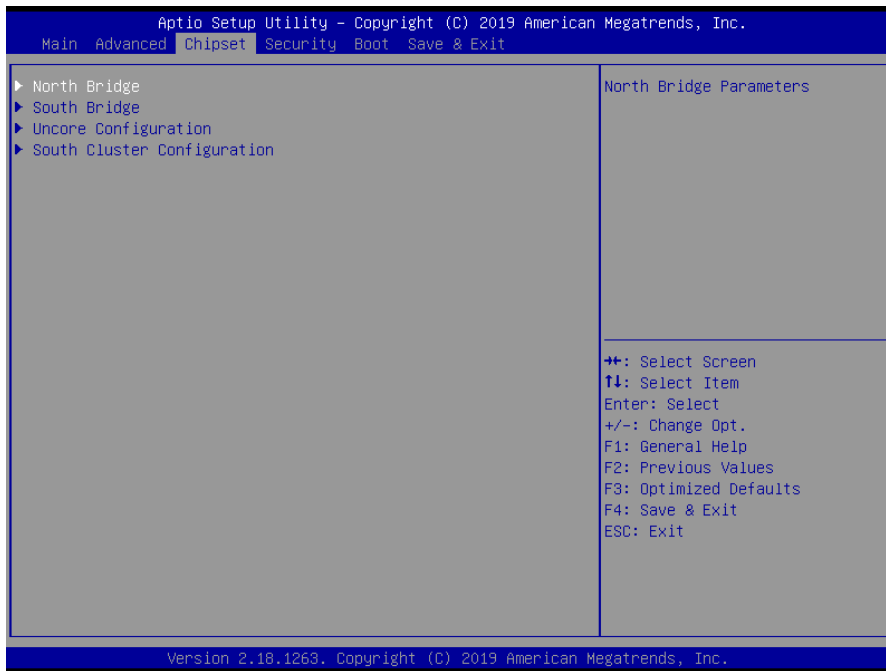

### 3.6.3.1 North Bridge

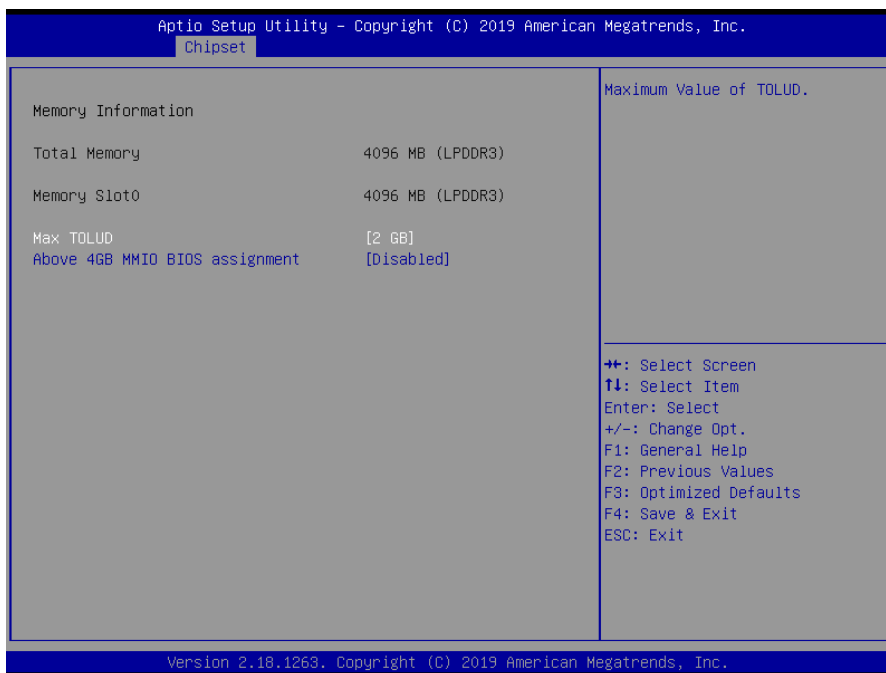

Item	Option	Description
<b>Max TOLUD</b>	2 GB[Default] 2.25 GB 2.5 GB 2.75 GB	Maximum Value of TOLUD.
<b>Above 4GB MMIO BIOS assignment</b>	Enabled Disabled[Default]	Enable/Disable above 4GB MemoryMapped IO BIOS assignment. This is disabled automatically when Aperture Size is set to 2048MB.

3.6.3.2 South Bridge

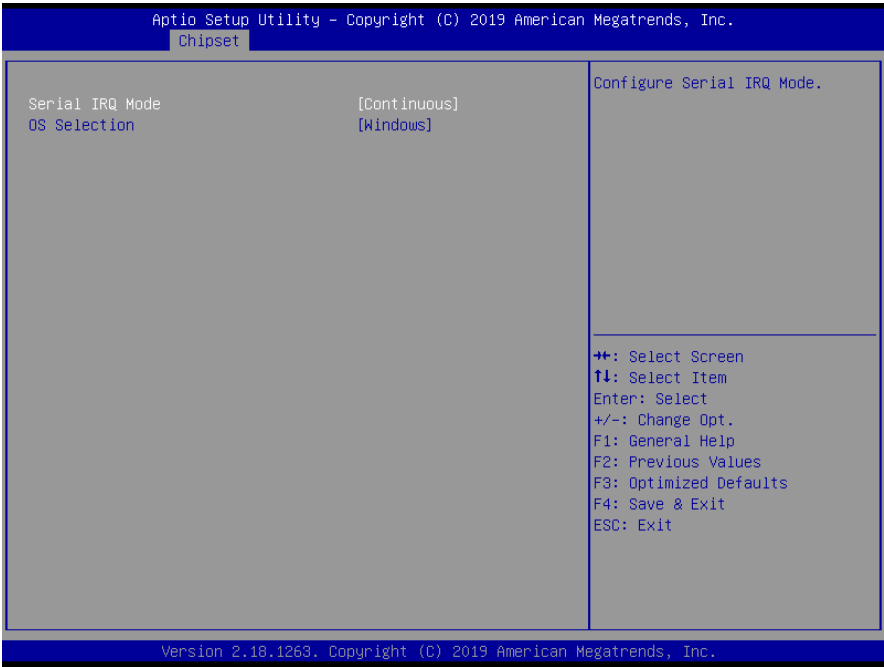

Item	Option	Description
Serial IRQ Mode	Quiet Continuous[Default]	Configure Serial IRQ Mode.
OS Selection	Windows[Default] Android Intel Linux	Select the target OS.

3.6.3.3 Uncore Configuration

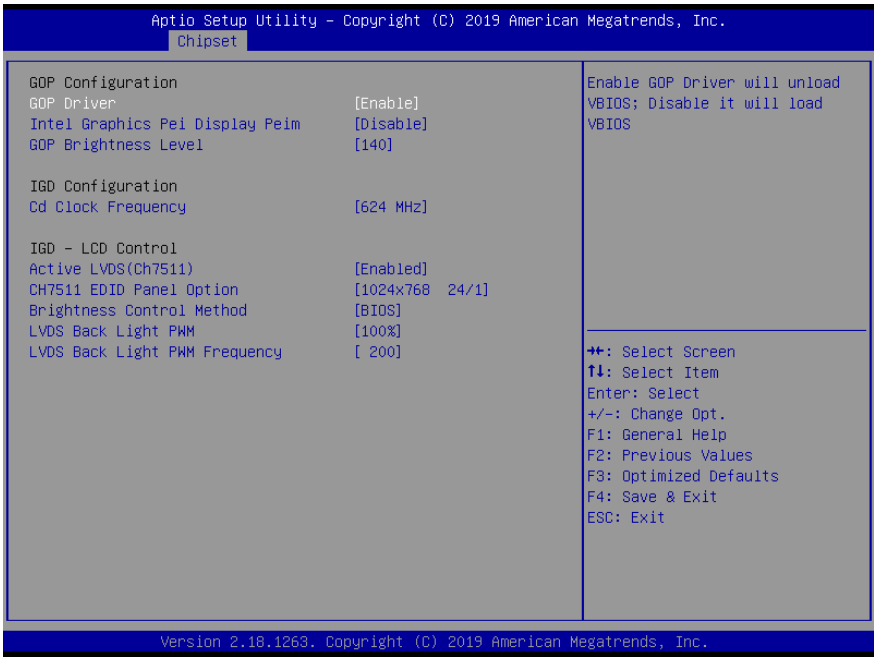

## ESM-APLM User's Manual

Item	Option	Description
<b>GOP Driver</b>	Enable[Default] Disable	Enable GOP Driver will unload VBIOS ; Dsiable it will load VBIOS.
<b>Intel Graphics Pei Display Peim</b>	Enable Disable[Default]	Enable/Disable Pei (Early) Display.
<b>GOP Brightness Level</b>	20/40/60/80/100/120/140[Default] /160/180/200/220/240/255	Set GOP Brightness Level ; Value ranges from 0-255.
<b>Cd Clock Frequency</b>	144 MHz 288 MHz 384 MHz 576 MHz 624 MHz[Default]	Select the highest Cd Clock frequency supported by the platform.
<b>Active LVDS (Ch7511)</b>	Disabled Enabled[Default]	Active Internal LVDS(eDP->Ch7511-to-LVDS).
<b>CH7511 EDID Panel Option</b>	1024x768 24/1[Default] 800x600 18/1 1024x768 18/1 1366x768 18/1 1024x600 18/1 1280x800 18/1 1366x768 24/1	Port1-EDP to LVDS(Chrotel 7511) Panel EDID Option.
<b>Brightness Control Method</b>	BIOS[Default]	LVDS Brightness Control Method. 1.BIOS
<b>LVDS Back Light PWM</b>	00% 25% 50% 75% 100%[Default]	Select LVDS back light PWM duty.
<b>LVDS Back Light PWM Frequency</b>	200[Default] 300 400 500 700 1k 2k 3k 5k 10k 20k	Select LVDS back light PWM Frequency.

3.6.3.4 South Cluster Configuration

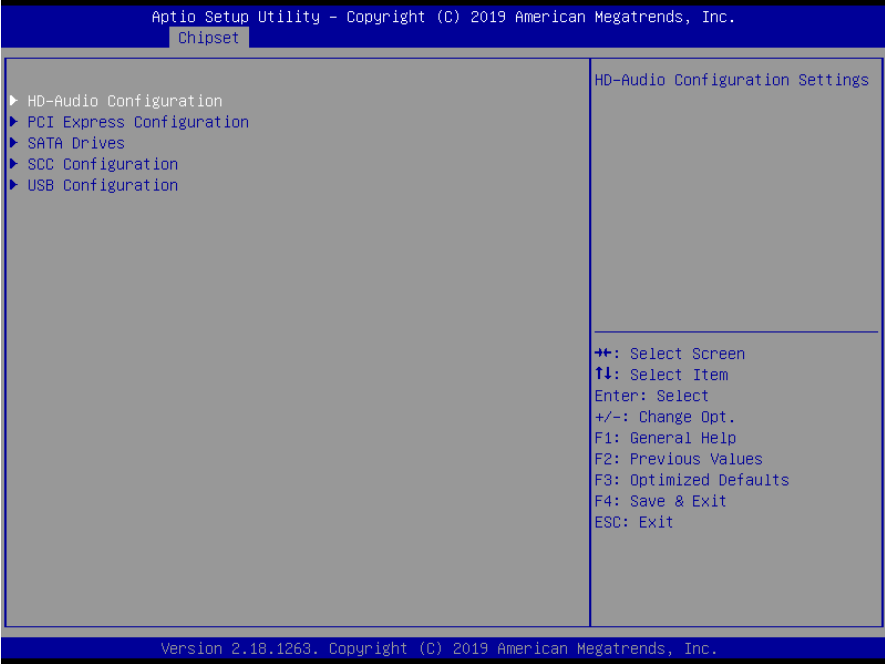

3.6.3.4.1 HD-Audio Configuration

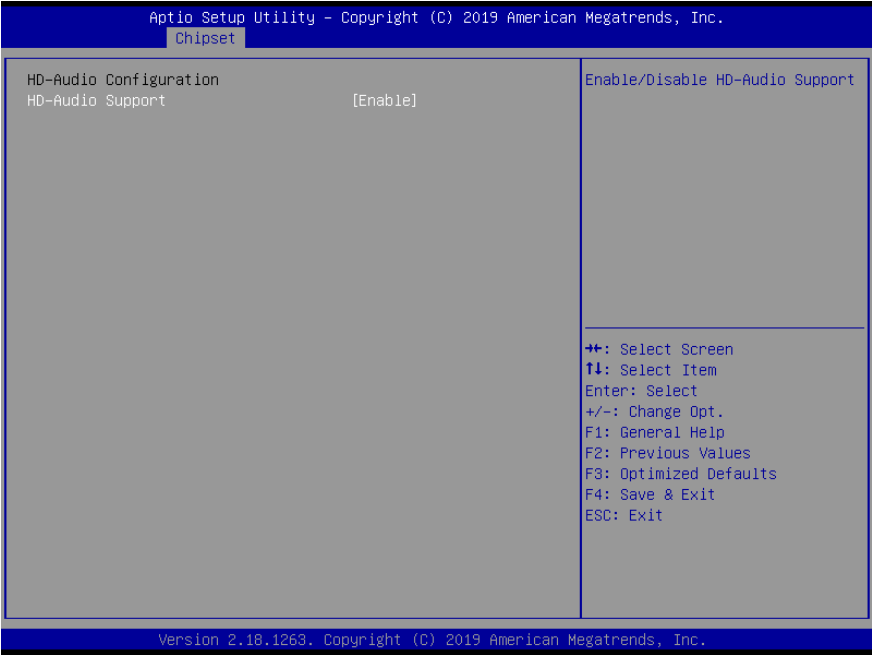

Item	Option	Description
HD-Audio Support	Disable Enable[Default]	Enable/Disable HD-Audio Support.

3.6.3.4.2 PCI Express Configuration

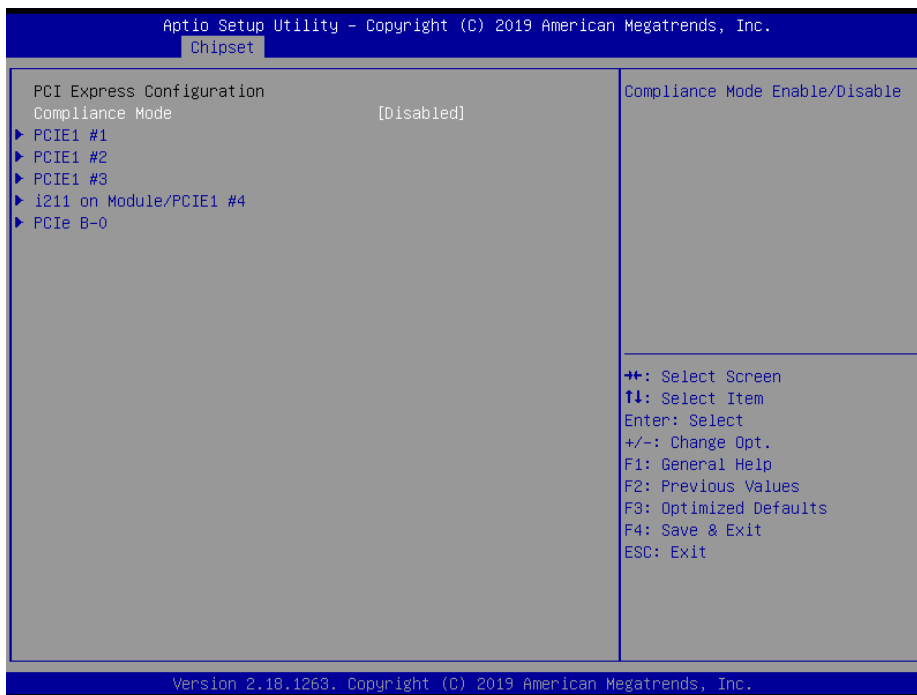

Item	Option	Description
Compliance Mode	Disabled[Default] Enabled	Compliance Mode Enable/Disable.

3.6.3.4.2.1 PCIE1 #1

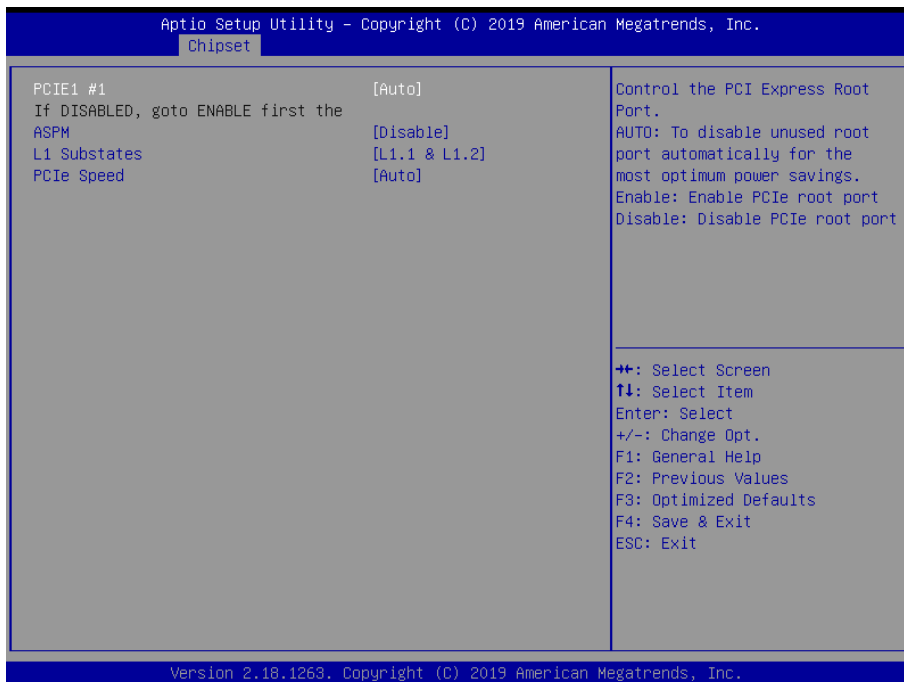



Item	Option	Description
PCIE1 #1	Disable Enable Auto[Default]	Control the PCI Express Root Port. AUTO: To disable unused root port automatically for the most optimum power savings. Enable: Enable PCIe root port Disabled PCIe root port.
ASPM	Disable[Default] L0s L1 L0sL1 Auto	PCI Express Active State Power Management settings.
L1 Substates	Disabled L1.1 L1.2 L1.1 & L1.2[Default]	PCI Express L1 Substates settings.
PCIe Speed	Auto[Default] Gen1 Gen2	Configure PCIe Speed.

3.6.3.4.2.2 PCIE1 #2

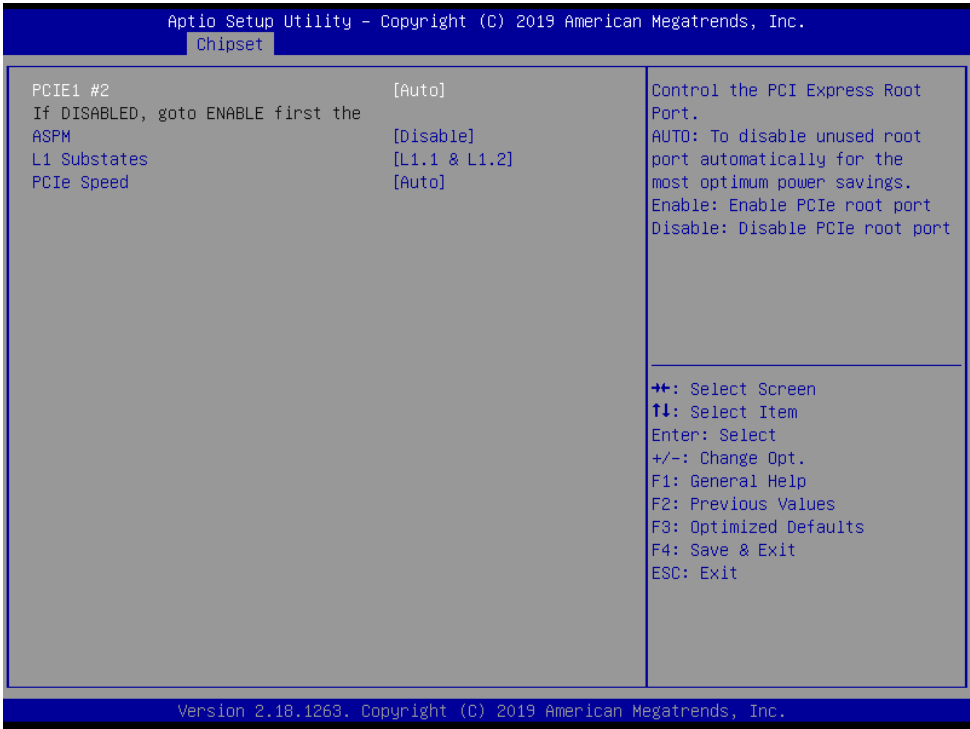

Item	Option	Description
PCIE1 #2	Disable Enable Auto[Default]	Control the PCI Express Root Port. AUTO: To disable unused root port automatically for the most optimum power savings. Enable: Enable PCIe root port Disabled PCIe root port.

## ESM-APLM User's Manual

<b>ASPM</b>	Disable[Default] L0s L1 L0sL1 Auto	PCI Express Active State Power Management settings.
<b>L1 Substates</b>	Disabled L1.1 L1.2 L1.1 & L1.2[Default]	PCI Express L1 Substates settings.
<b>PCIe Speed</b>	Auto[Default] Gen1 Gen2	Configure PCIe Speed.

### 3.6.3.4.2.3 PCIE1 #3

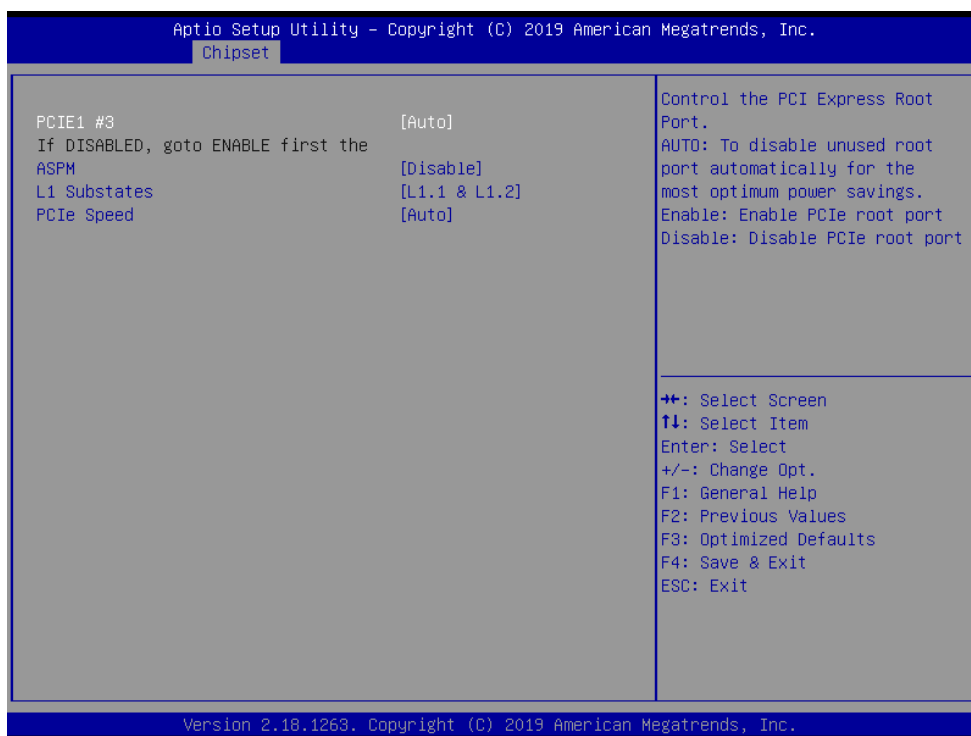

Item	Option	Description
<b>PCIE1 #3</b>	Disable Enable Auto[Default]	Control the PCI Express Root Port. AUTO: To disable unused root port automatically for the most optimum power savings. Enable: Enable PCIe root port Disabled PCIe root port.
<b>ASPM</b>	Disable[Default] L0s L1 L0sL1 Auto	PCI Express Active State Power Management settings.
<b>L1 Substates</b>	Disabled L1.1 L1.2	PCI Express L1 Substates settings.

	L1.1 & L1.2[Default]	
<b>PCIe Speed</b>	Auto[Default] Gen1 Gen2	Configure PCIe Speed.

3.6.3.4.2.4 i211 on Module/PCIE1 #4

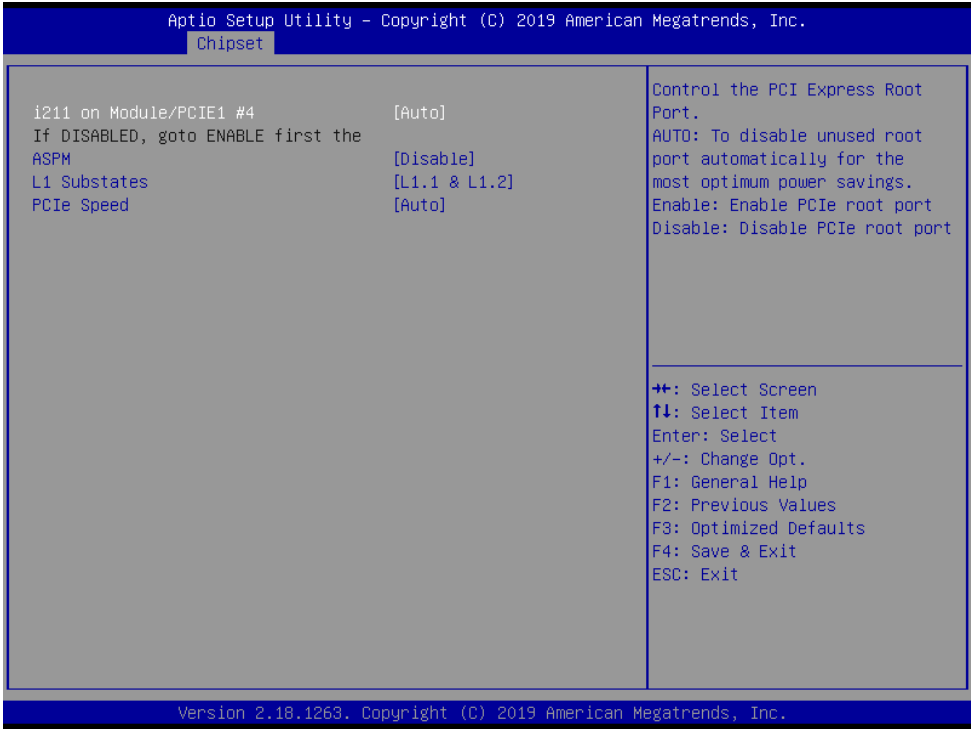

Item	Option	Description
<b>i211 on Module/PCIE1 #4</b>	Disable Enable Auto[Default]	Control the PCI Express Root Port. AUTO: To disable unused root port automatically for the most optimum power savings. Enable: Enable PCIe root port Disabled PCIe root port.
<b>ASPM</b>	Disable[Default] L0s L1 L0sL1 Auto	PCI Express Active State Power Management settings.
<b>L1 Substates</b>	Disabled L1.1 L1.2 L1.1 & L1.2[Default]	PCI Express L1 Substates settings.
<b>PCIe Speed</b>	Auto[Default] Gen1 Gen2	Configure PCIe Speed.

**Note:**

Default: i211 on Module

H/W Option: PCIE1 #4

3.6.3.4.2.5 PCIe B-0

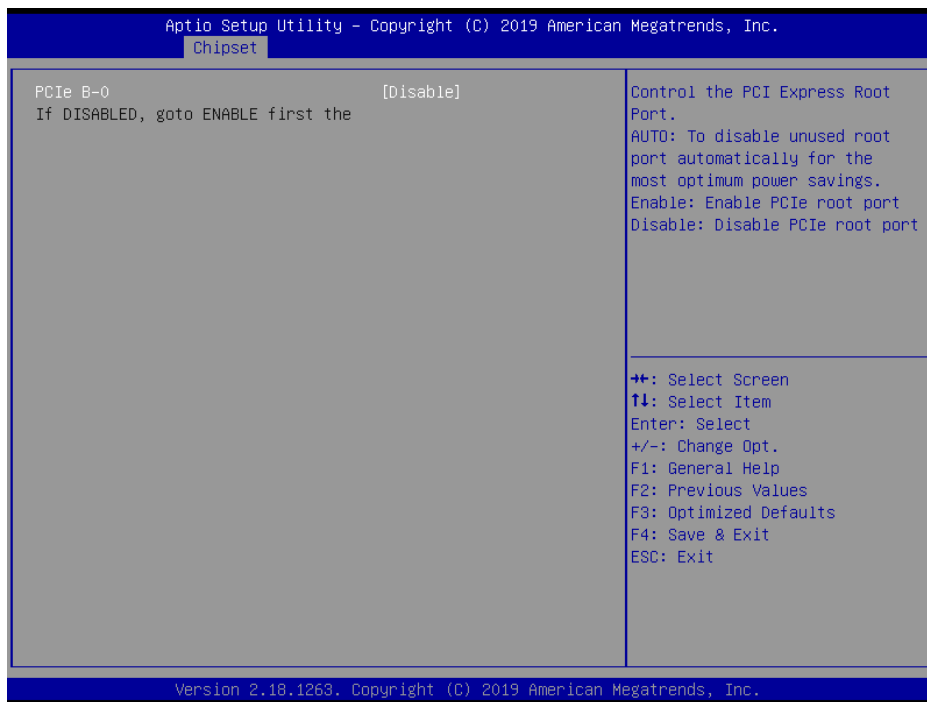

Item	Option	Description
PCIe B-0	Disable Enable Auto[Default]	Control the PCI Express Root Port. AUTO: To disable unused root port automatically for the most optimum power savings. Enable: Enable PCIe root port Disabled PCIe root port.

**Note:**

H/W Option function.

3.6.3.4.3 SATA Drivers

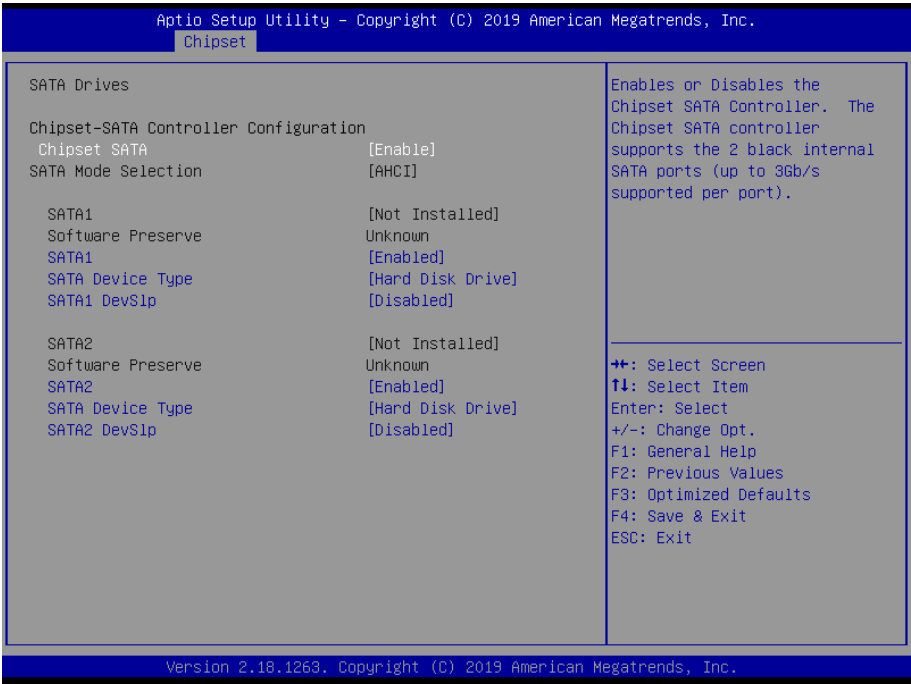

Item	Option	Description
<b>Chipset SATA</b>	Enable[Default] Disable	Enables or Disables the Chipset SATA Controller. The Chipset SATA controller supports the 2 black internal SATA ports (up to 3Gb/s supported per port).
<b>SATA 1/2</b>	Disabled Enabled[Default]	Enable or Disable SATA Port.
<b>SATA Device Type</b>	Hard Disk Drive[Default] Solid State Drive	Identify the SATA port is connected to Solid State Drive or Hard Disk Drive.
<b>SATA1/2 DevSlp</b>	Disabled[Default] Enabled	Enable/Disable SATA1/2 DevSlp. Board rework for LP needed before enable.

3.6.3.4.4 SCC Configuration

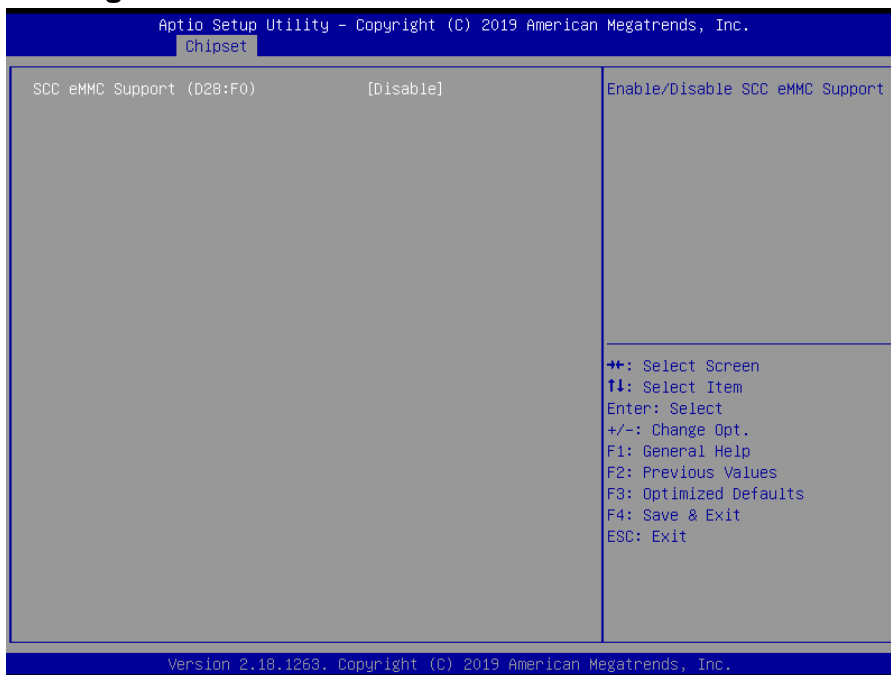

Item	Option	Description
SCC eMMC Support (D28:F0)	Enable Disable[Default]	Enable/Disable SCC eMMC Support.

**Note:**

H/W Option function (optional).

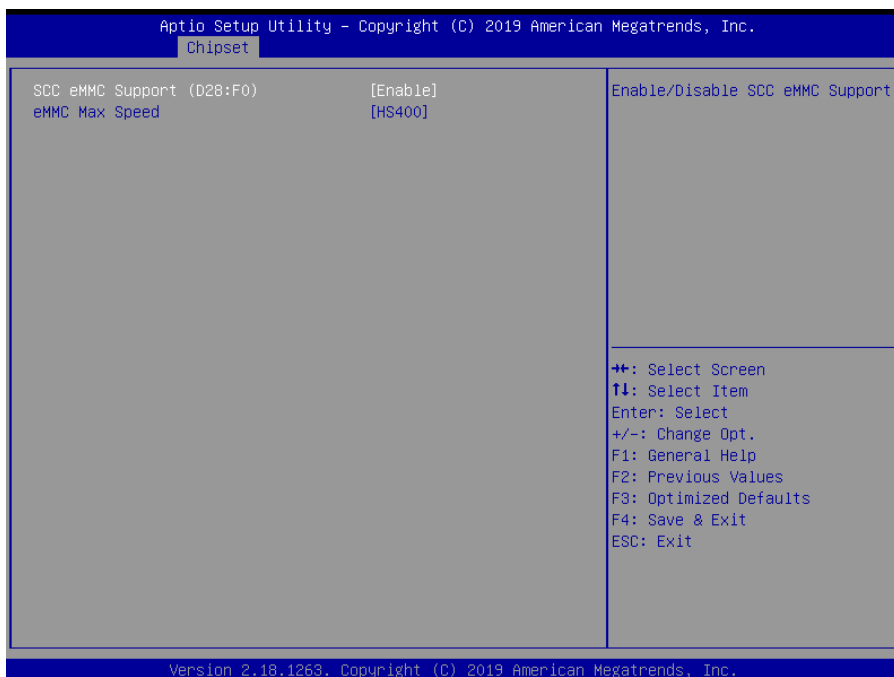

When the SCC eMMC Support (D28:F0) is Enabled

Item	Option	Description
eMMC Max Speed	HS400[Default] HS200 DDR50	Select the eMMC max Speed allowed.

3.6.3.4.4 USB Configuration

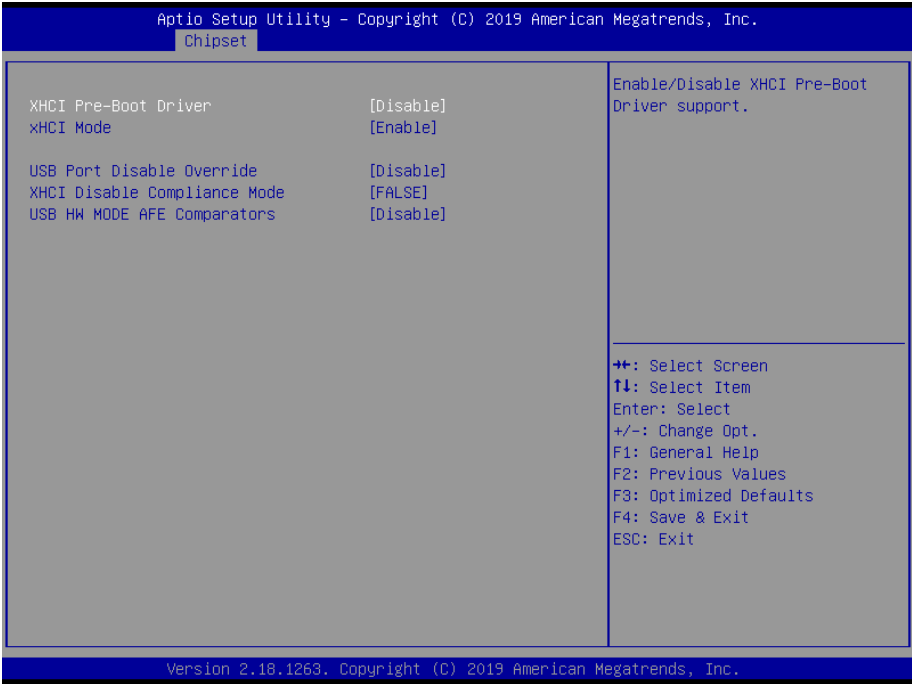

Item	Option	Description
XHCI Pre-Boot Driver	Enable Disable[Default]	Enable/Disable XHCI Pre-Boot Driver support.
xHCI Mode	Enable[Default] Disable	Once disabled, XHCI controller would be function disabled, none of the USB devices are detectable and usable during boot and in OS. Do not disable it unless for debug purpose.
USB Port Disable Override	Enable Disable[Default]	Selectively Enable/Disable the corresponding USB port from reporting a Device Connection to the controller.
XHCI Disable Compliance Mode	FALSE[Default] TRUE	Options to disable XHCI Link Compliance Mode. Default is FALSE to not disable Compliance Mode. Set TRUE to disable Compliance Mode.
USB HW MODE AFE Comparators	Enable Disable[Default]	Enable/Disable USB HW MODE AFE Comparators.

### 3.6.4 Security

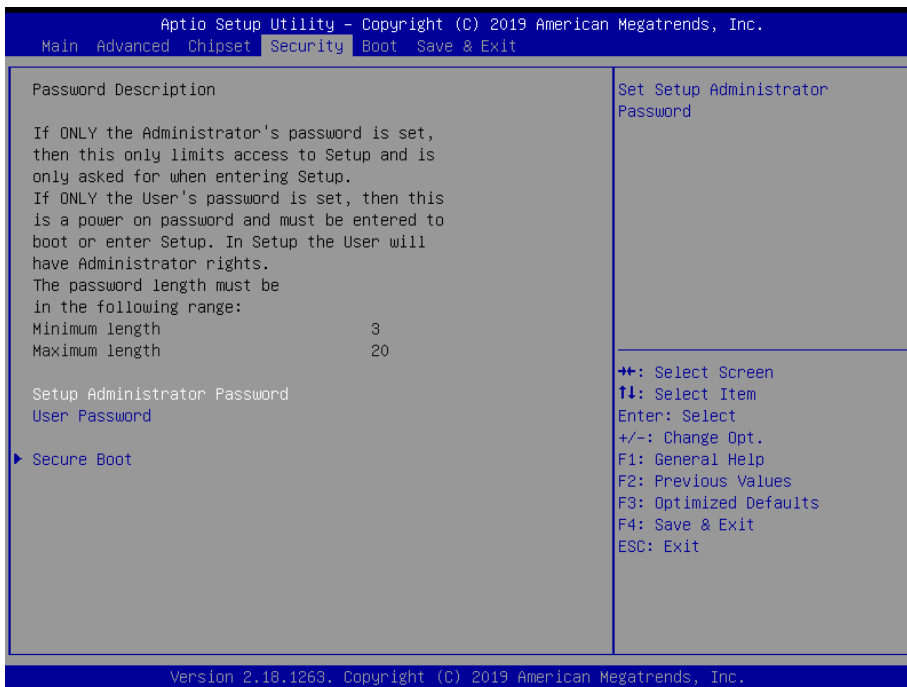

- **Setup Administrator Password**

Set setup Administrator Password

- **User Password**

Set User Password

#### 3.6.4.1 Secure Boot

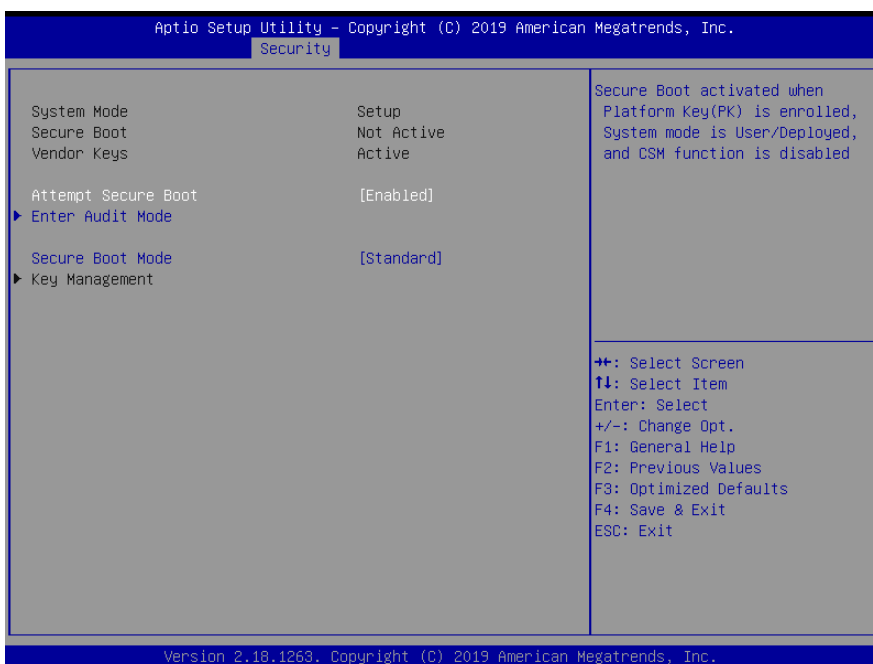



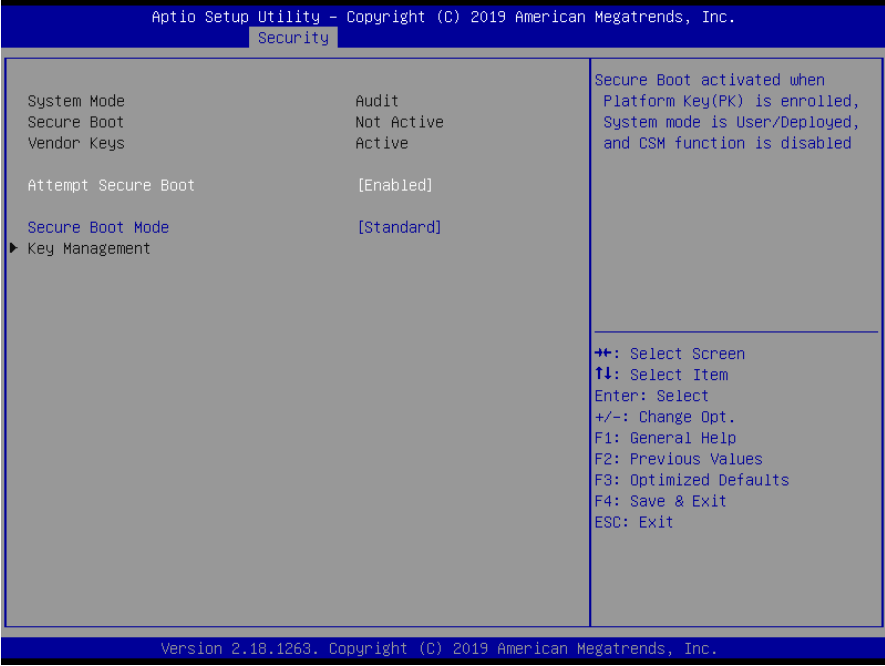

Item	Option	Description
<b>Attempt Secure Boot</b>	Disabled Enabled[Default]	Secure Boot activated when Platform Key(PK) is enrolled, System mode is User/Deployed, and CSM function is disabled.
<b>Secure Boot Mode</b>	Standard[Default] Customized	Secure Boot Mode – Custom_Standard, Set UEFI Secure Boot Mode to STANDARD mode or CUSTOM mode, this change is effect after save. And after reset, the mode will return to STANDARD mode.

3.6.5 Boot

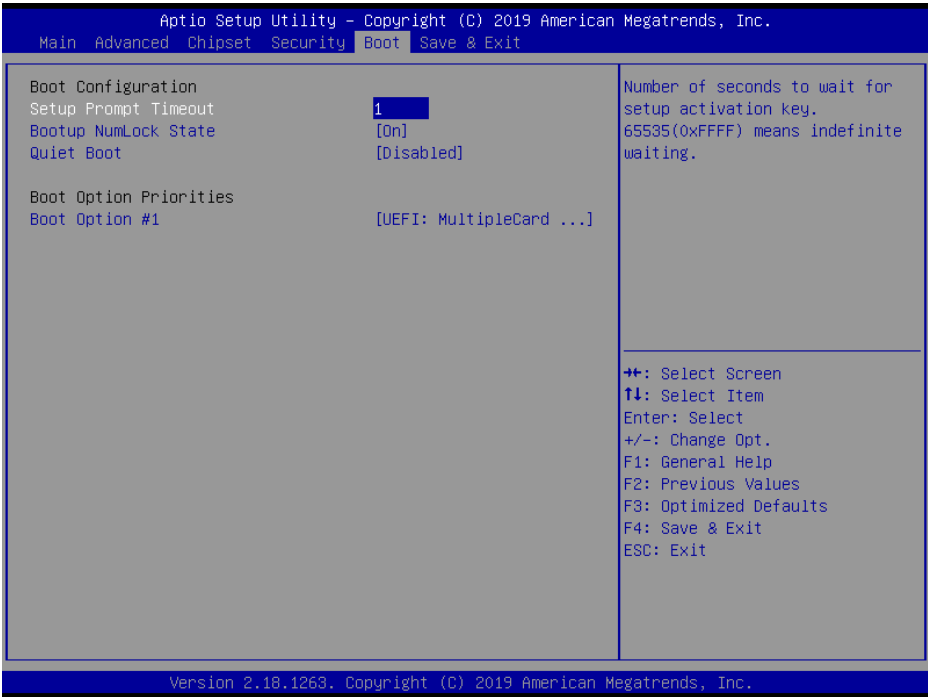

## ESM-APLM User’s Manual

Item	Option	Description
Setup Prompt Timeout	1~ 65535	Number of seconds to wait for setup activation key. 65535(0xFFFF) means indefinite waiting.
Bootup NumLock State	On[Default] Off	Select the Keyboard NumLock state
Quiet Boot	Disabled[Default] Enabled	Enables or disables Quiet Boot option
Boot Option #1	Set the system boot order.	

### 3.6.6 Save and exit

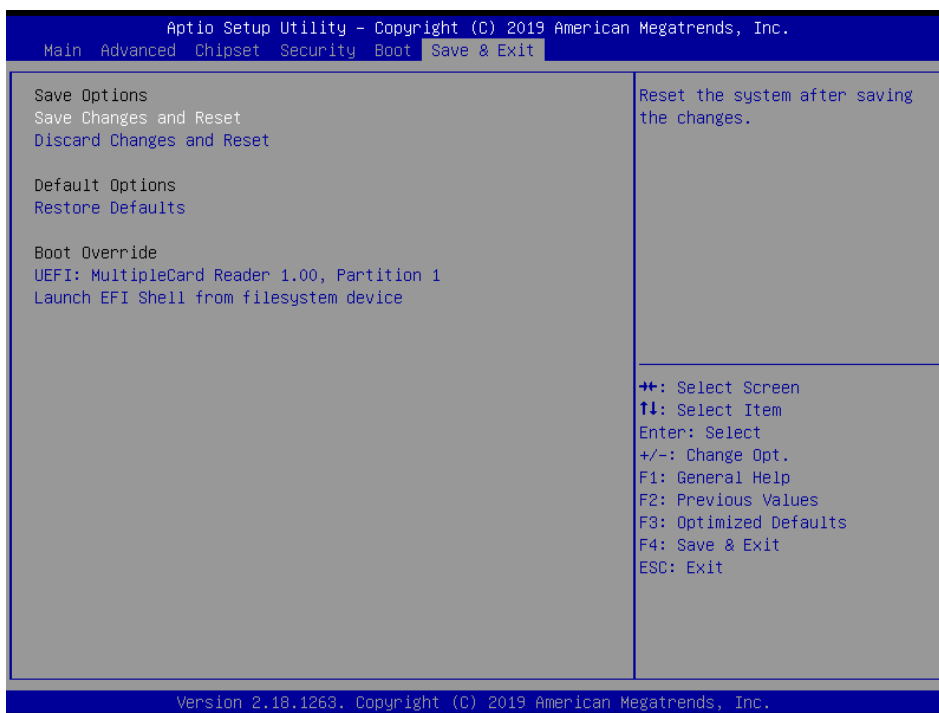

#### 3.6.6.1 Save Changes and Reset

Reset the system after saving the changes.

#### 3.6.6.2 Discard Changes and Reset

Any changes made to BIOS settings during this session of the BIOS setup program are discarded. The setup program then exits and reboots the controller.

#### 3.6.6.3 Restore Defaults

This option restores all BIOS settings to the factory default. This option is useful if the controller exhibits unpredictable behavior due to an incorrect or inappropriate BIOS setting.

**3.6.6.4 Launch EFI Shell from filesystem device**

Attempts to Launch EFI Shell application (Shellx64.efi) from one of the available filesystem devices.

# 4. Drivers Installation

---



**Note:** Installation procedures and screen shots in this section are for your reference and may not be exactly the same as shown on your screen.

# 4.1 Install Chipset Driver

All drivers can be found on the Avalue Official Website:

<http://www.avalue.com.tw>.



**Note:** The installation procedures and screen shots in this section are based on Windows 10 operation system. If the warning message appears while the installation process, click Continue to go on.

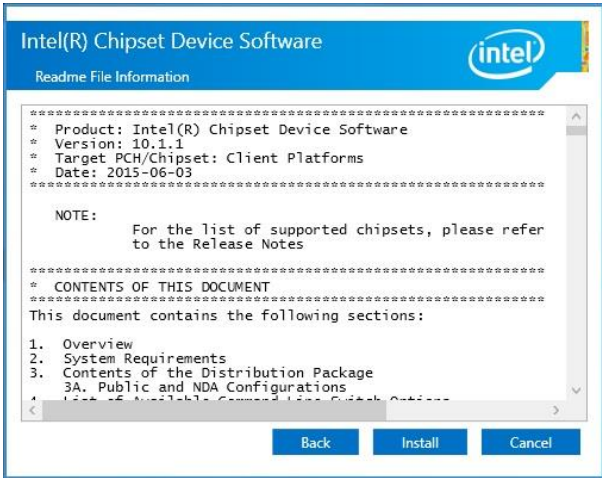

**Step 3. Click Install.**



**Step1. Click Next.**

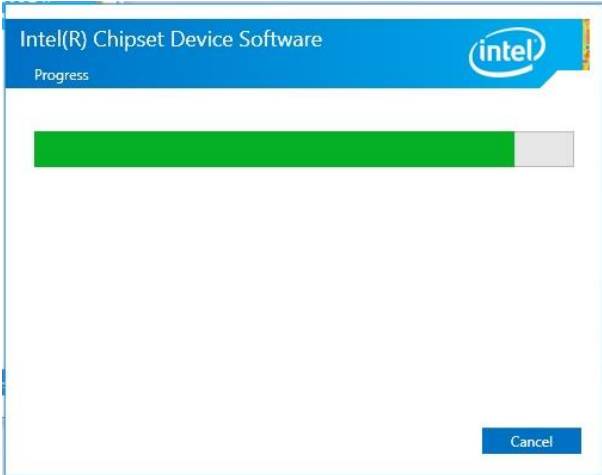

**Step 4. Installing.**



**Step 2. Click Accept.**



**Step 5. Complete setup.**

## 4.2 Install TXE Driver

All drivers can be found on the Avalue Official Website:

<http://www.avalu.com.tw>.



**Note:** The installation procedures and screen shots in this section are based on Windows 10 operation system. If the warning message appears while the installation process, click Continue to go on.



**Step 3.** Click **Next** to continue installation.

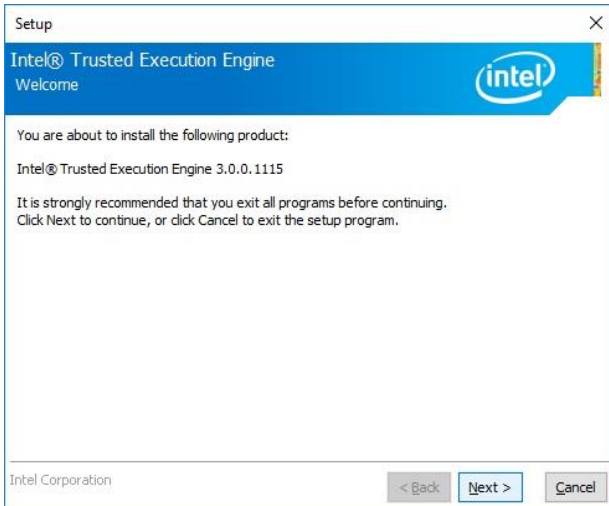

**Step1.** Click **Next** to start installation.

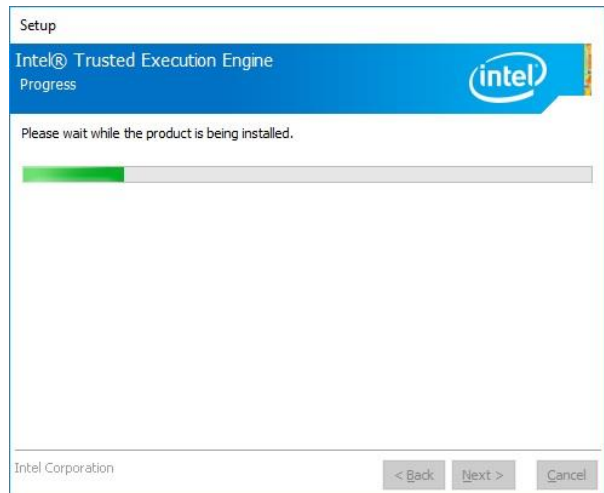

**Step 4.** Installing.

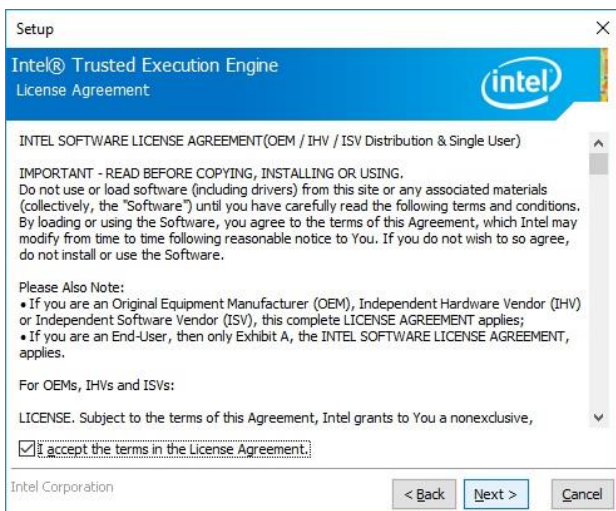

**Step 2.** Click **Next**.

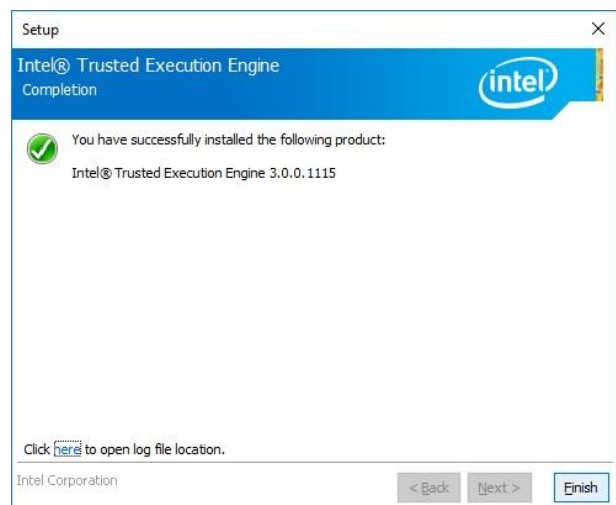

**Step 5.** Click **Finish** to complete setup.

### 4.3 Install VGA Driver

All drivers can be found on the Avalue Official Website:  
<http://www.avalue.com.tw>.



**Note:** The installation procedures and screen shots in this section are based on Windows 10 operation system.

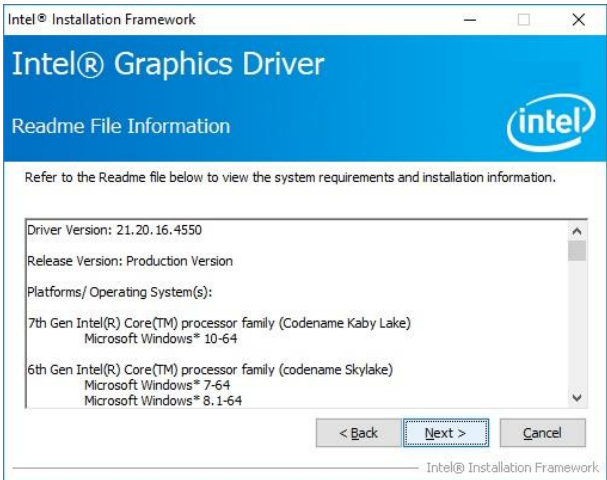

**Step 3. Click Next.**



**Step 1. Click Next** to continue installation.

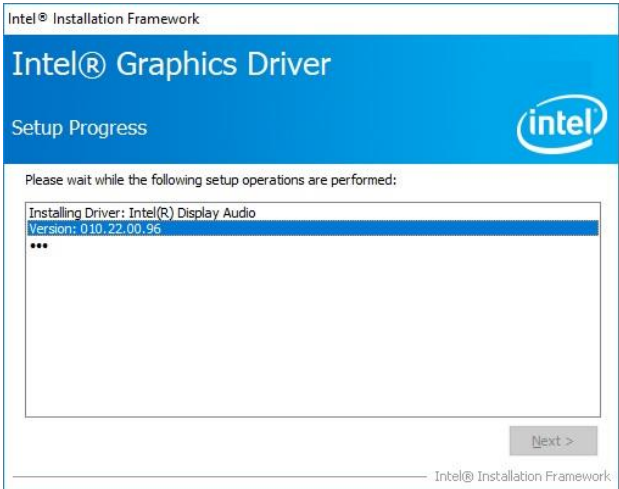

**Step 4. Click Next.**

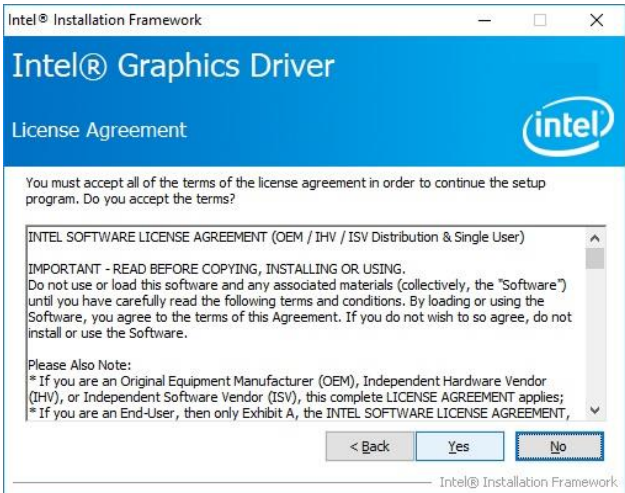

**Step 2.**  
Click **Yes** to accept license agreement.

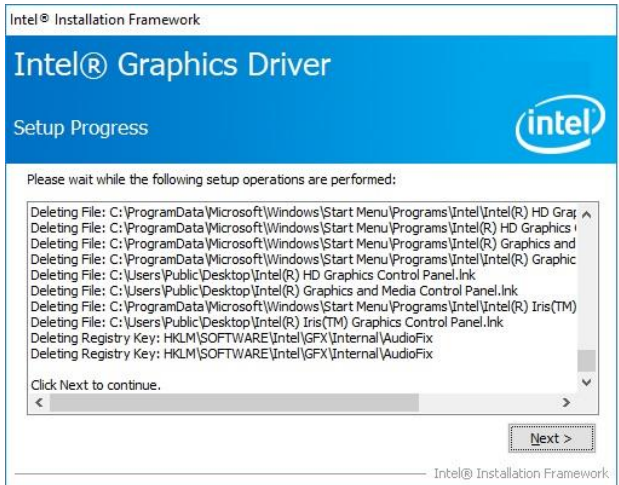

**Step 5. Click Next.**

## ESM-APLM User's Manual

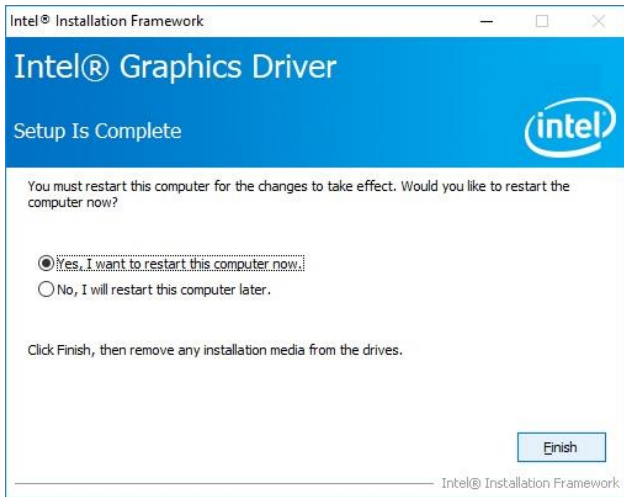

**Step 6.** Click **Finish** to complete setup.



## 4.4 Install Audio Driver

All drivers can be found on the Avalue Official Website:  
<http://www.avalue.com.tw>.



**Note:** The installation procedures and screen shots in this section are based on Windows 10 operation system.

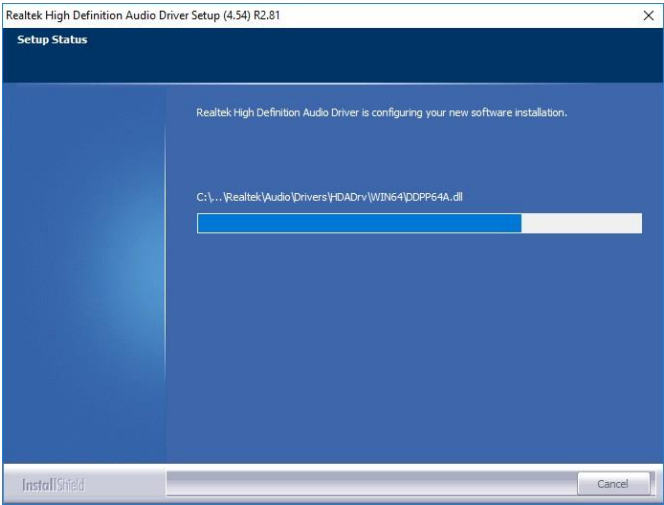

**Step 3. Installing.**

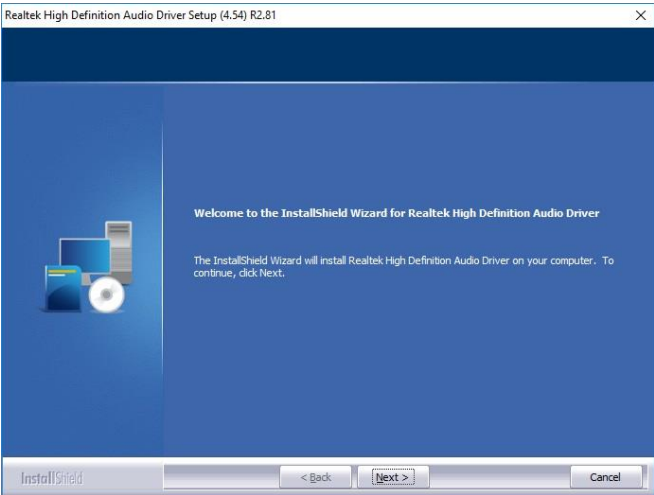

**Step 1. Click Next** to continue setup.

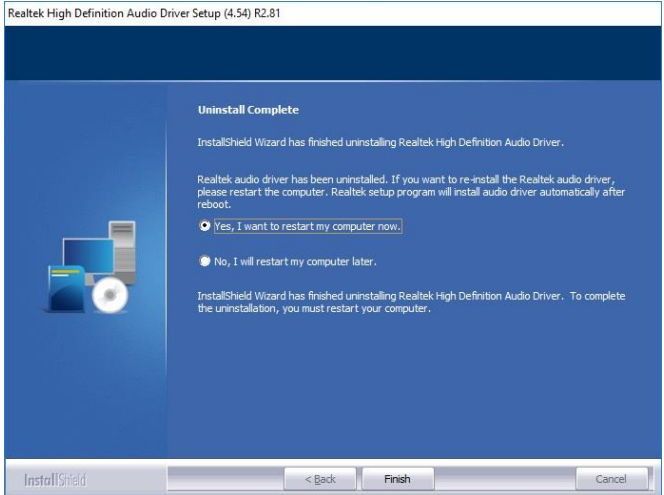

**Step 4. Click Finish** to complete the setup.

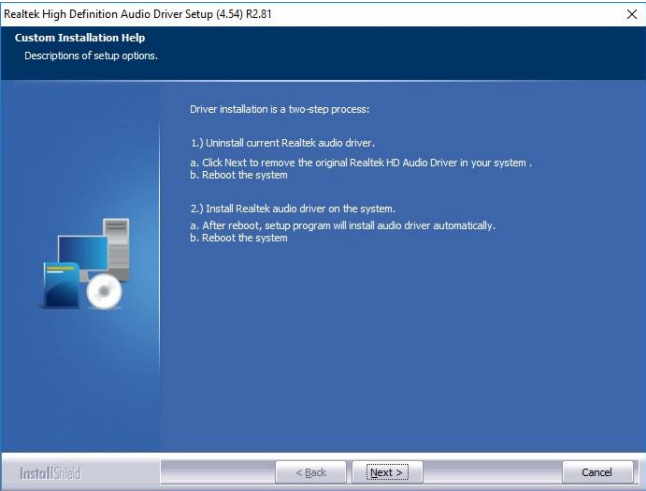

**Step 2. Click Next.**

## 4.5 Install Ethernet Driver

All drivers can be found on the Avalue Official Website:  
<http://www.avalue.com.tw>.



**Note:** The installation procedures and screen shots in this section are based on Windows 10 operation system.

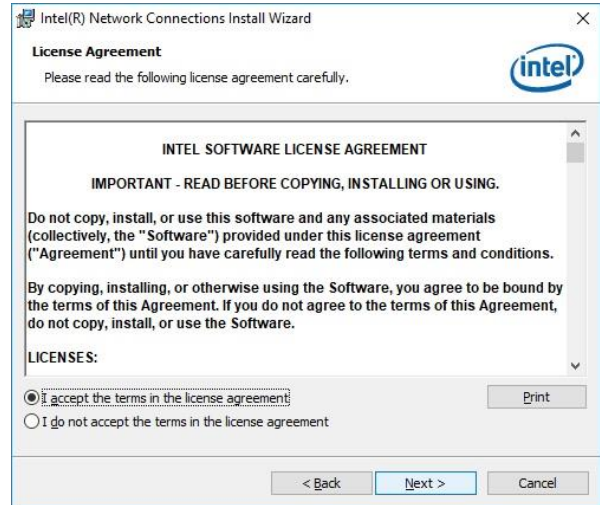

**Step 3.** Click **Next** to continue setup.

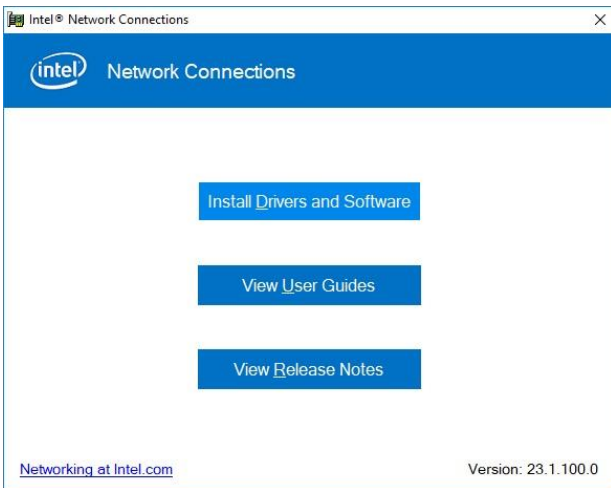

**Step 1.** Click **Install Drivers and Software**.

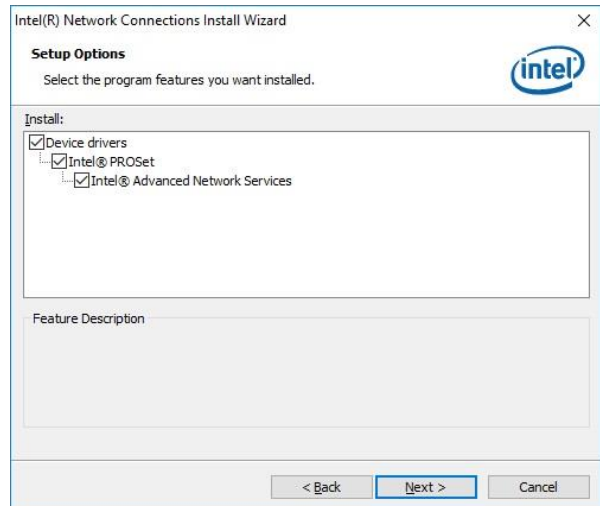

**Step 4.** Click **Next**.

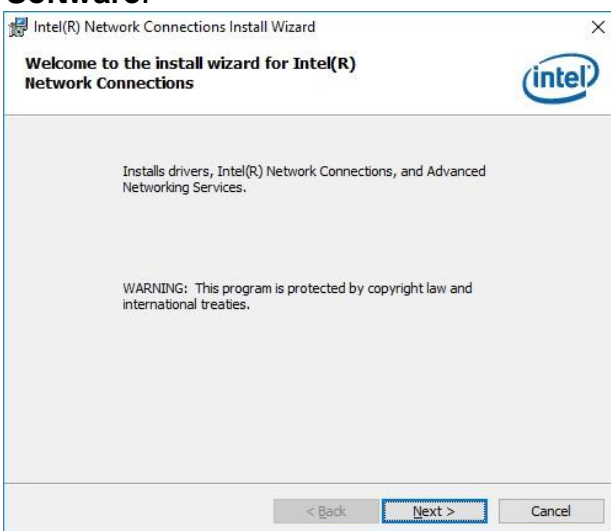

**Step 2.** Click **Next**.

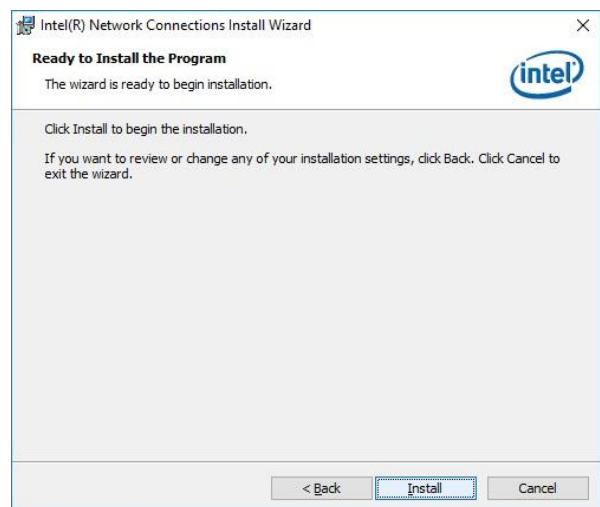

**Step 5.** Click **Install**.

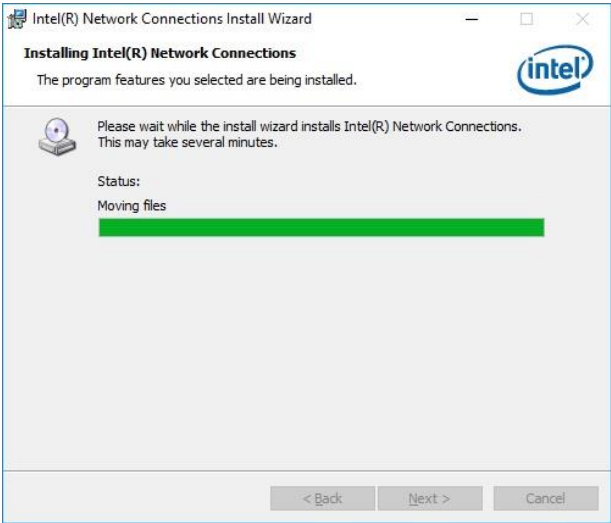

Step 6. Installing.

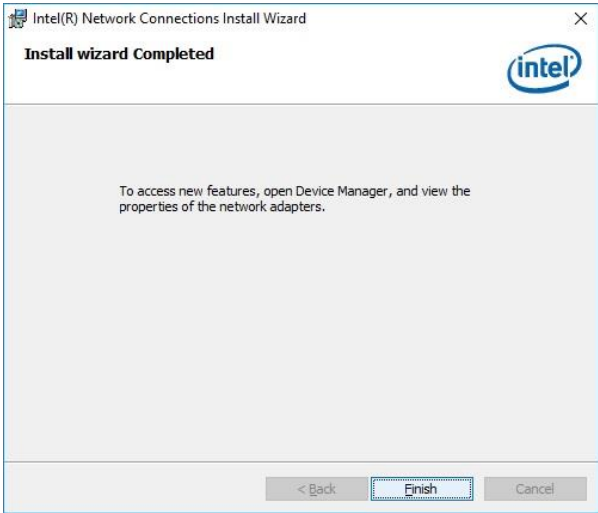

Step 7. Click **Finish** to complete the setup.

# 5. Mechanical Drawing

---

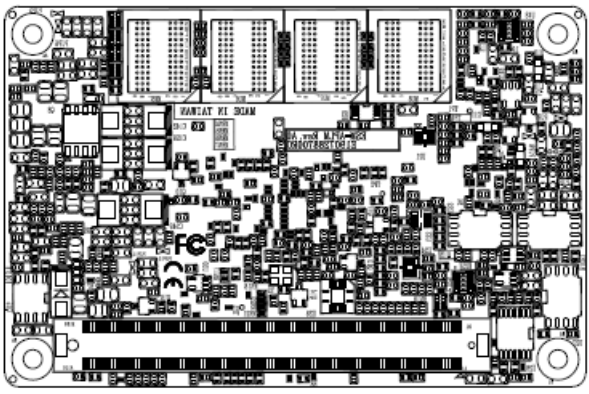
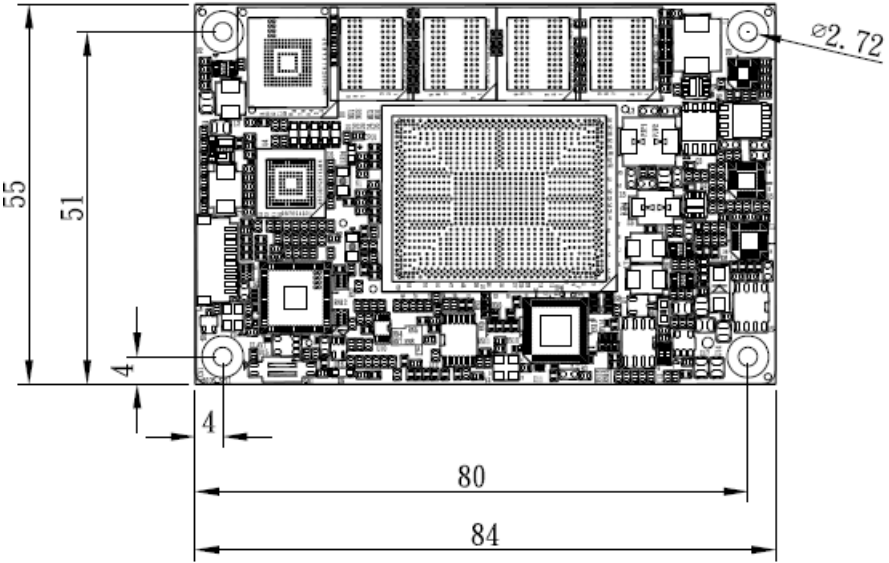

Unit: mm

